

TR93P

Cooker size	90x60 cm
N. of cavities with energy label	2
Cavity heat source	Electric
Hob type	Gas
Type of main oven	Thermo-ventilated
Type of second oven	Thermo-ventilated
Cleaning system main oven	Vapor Clean
EAN code	8017709181703
Energy efficiency class	A
Energy efficiency class, second cavity	B



Aesthetics



Aesthetics	Victoria	Display	electronic 5 buttons
Colour	Cream	Colour of buttons	Black
Design	Victoria	No. of controls	10
Door	With frame	Serigraphy colour	Black
Upstand	Yes	Handle	Smeg Victoria
Type of pan stands	Cast Iron	Handle Colour	Brushed stainless steel
Hob colour	Black enamel	Glass type	Black
Command panel finish	Enamelled metal	Plinth	Anthracite
Control knobs	Smeg Victoria	Logo	assembled 50's
Controls colour	Stainless steel	Logo position	Upstand+ Command panel

Programs / Functions

No. of cooking functions 5
Traditional cooking functions



Static



Fan assisted



Circulaire



ECO



Fan assisted base

Cleaning functions



Vapor Clean

Other functions

 Defrost by time

Programs / Functions Auxiliary Oven

Cooking functions cavity 2 1
Traditional cooking functions, cavity 2

 Circulaire

Programme / Functions Third Oven

No. of functions third oven 1

Oven light 

Full grill 

Hob technical features

UR

Total no. of cook zones 6

Front left - Gas - 2UR (dual) - 4.20 kW

Rear left - Gas - AUX - 1.00 kW

Front centre - Gas - AUX - 1.00 kW

Rear centre - Gas - Semi Rapid - 1.80 kW

Front right - Gas - Semi Rapid - 1.80 kW

Rear right - Gas - Rapid - 2.90 kW

Type of gas burners Standard

Gas safety valves Yes

Automatic electronic ignition Yes

Burner caps Matt black enamelled

Main Oven Technical Features



No. of lights 1

Fan number 1

Net volume of the cavity 61 litres

Gross volume, 1st cavity 70 l

Cavity material Easy clean enamel

Shelf positions 4

Type of shelves Metal racks

Light type Halogen

Light power 40 W

Cooking time setting Start and Stop

Door opening Side opening

Removable inner door Yes

Total no. of door glasses 3

No. of thermo-reflective door glasses 1

Safety Thermostat Yes

Cooling system Tangential

Usable cavity space dimensions (HxWxD) 316x460x412 mm

Temperature control Electro-mechanical

Lower heating element power 1200 W

Side opening door	Yes	Upper heating element - Power	1000 W
Removable door	Yes	Grill element	1700 W
Full glass inner door	Yes	Large grill - Power	2700 W
		Circular heating element - Power	2000 W
		Grill type	Electric
		Tilting grill	Yes

Options Main Oven

Timer	Yes	Minimum Temperature	50 °C
End of cooking acoustic alarm	Yes	Maximum temperature	260 °C

Second Oven Technical Features



Net volume of the second cavity	62 litres	Full glass inner door	Yes
Gross volume, 2nd cavity	69 l	Removable inner door	Yes
Cavity material	Easy clean enamel	No. total door glasses	2
Shelf positions	9	No. thermo-reflective door glasses	1
Type of shelves	Metal racks	Safety Thermostat	Yes
No. of lights	1	Cooling system	Tangential
Light type	Halogen	Usable cavity space dimensions (HxWxD)	605x275x370 mm
Light power	40 W	Temperature control	Electro-mechanical
Door opening	Side opening	Circular heating element - Power	2500 W
Side opening door	Yes	Grill type	Electric
Removable door	Yes		

Options Auxiliary Oven

Minimum Temperature	50 °C	Maximum temperature	245 °C
---------------------	-------	---------------------	--------

Third Oven Technical Features



Net volume, 3rd cavity	35 l	Removable inner door	Yes
Gross volume, 3rd cavity	41 l	No. total door glasses	3
Cavity material	Easy clean enamel	No. of thermo-reflective door glasses	1
Shelf positions	2	Safety Thermostat	Yes
Type of shelves	Metal racks	Cooling system	Tangential
No. of lights	1	Usable cavity space dimensions (HxWxD)	169x440x443 mm
Light type	Halogen	Temperature control	Electro-mechanical
Light power	40 W		

Door opening	Flap down	Large grill - Power	2700 W
Removable door	Yes	Grill type	Electric
Full glass inner door	Yes	Tilting grill	Yes

Options Third Oven

Minimum Temperature	50 °C	Maximum temperature	260 °C
---------------------	-------	---------------------	--------

Accessories included for Main Oven & Hob



Cast iron wok support	1	40mm deep tray	1
Moka stand in cast iron	1	Grill mesh	1
Rack with back and side stop	2	Telescopic Guide rails, partial Extraction	1

Accessories included for Secondary Oven



Chrome shelf with back stop	4	Plate rack/warmer	1
-----------------------------	---	-------------------	---

Accessories included for Third Oven

Rack with back and side stop	1	40mm deep tray	1
------------------------------	---	----------------	---

Electrical Connection

Nominal power	8300 W	Frequency	50/60 Hz
Current	36 A	Cable testing	Yes
Voltage	220-240 V	Terminal block	5 poles
Voltage 2 (V)	380-415 V		

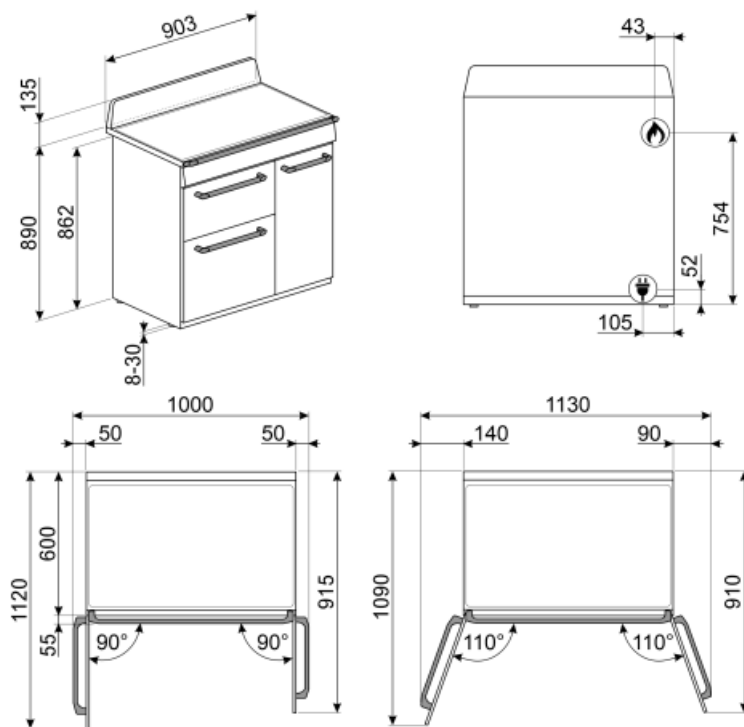

Not included accessories



TPKTR9

Teppanyaki grill plate for Victoria TR9 and Symphony cookers



SFLK1

Child lock



PRTX

Refractory pizza stone with handles. D=35cm Not suitable for microwave ovens. Suitable for gas ovens, to be put on the griddle.



BGTR9

Cast iron grill plate suitable for 90 cm Victoria, 60 and 90cm Master and Symphony cookers



BN620-1

Enamelled tray, 20mm deep



GT1P-2

Partially extractable telescopic guides (1 level) for ovens with metal frames. Length: 355.5 mm, extraction: 285 mm. Material: Stainless steel AISI 430 polished.

BBQ

Double sided plate BBQ. Suitable for recreating succulent and crispy dishes in the oven with the typical taste of grilled cooking. The ribbed side is particularly suitable for meats and cheeses. The smooth side for fish, seafood and vegetables.



AIRFRY

Air fryer rack AIRFRY . Ideal for recreating traditional frying in the oven, but with fewer calories and less fat. It allows you to cook quickly and simply dishes such as French fries, fried vegetables and fish, ensuring perfect browning and crispiness.



GTP

Partially extractable telescopic guides (1 level) Extraction: 300 mm Material: Stainless steel AISI 430 polished



BNP608T

Teflon-coated tray, 8mm depth, to be placed on the grid



KIT1TR9N

Splashback, 90x75 cm suitable for TR9 Victoria cookers, black



KITH93

Height extension kit (950 mm), suitable for TR93 cookers



KIT1TR9X

Splashback, 90x75 cm suitable for TR9 Victoria cookers, stainless steel



PALPZ

Pizza shovel with fold away handle width: 315mm length : 325mm

GTT

**Totally extractable telescopic guides
(1 level)** Extraction: 433 mm Material:
Stainless steel AISI 430 polished



SMOLD



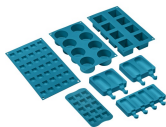





















Set of 7 silicone moulds for ice creams,
ice lollies, pralines, ice cubes or to
portion food. Usable from -60°C to
+230°C



BN640

Enamelled tray, 40mm deep

Symbols glossary

 <p>A: Product drying performance, measured from A+++ to D / G depending on the product family</p>	 <p>A-10%: Product energy rating, measured from A+++ to D / G depending on the product family.</p>
 <p>B: Product energy rating, measured from A+++ to D / G depending on the product family.</p>	 <p>Heavy duty cast iron pan stands: for maximum stability and strength.</p>
 <p>Air cooling system: to ensure a safe surface temperatures.</p>	 <p>Defrost by time: with this function the time of thawing of foods are determined automatically.</p>
 <p>Double glazed doors: Number of glazed doors.</p>	 <p>Triple glazed doors: Number of glazed doors.</p>
 <p>Enamel interior: The enamel interior of all Smeg ovens have a special antacid lining which helps keep the interior clean by reducing the amount of cooking grease adhering to it.</p>	 <p>Circogas: In gas ovens the fan distributes the heat quickly and evenly throughout the oven cavity, avoiding flavour transfer when cooking a number of different dishes at the same time. In electric ovens this combination completes cooking more quickly of foods that are ready on the surface, but that require more cooking inside, without further browning.</p>
 <p>Fan with upper and lower elements: The elements combined with the fan aim to provide more uniform heat, a similar method to conventional cooking, so pre-heat is required. Most suitable for items requiring slow cooking methods.</p>	 <p>Upper and lower element only: a traditional cooking method best suited for single items located in the centre of the oven. the top pf the oven will always be hottest. Ideal for roast, fruit cakes, bread etc.</p>
 <p>Circulaire: The combination of the fan and circular element around it gives a hot air cooking method. This provides many benefits including no preheat if cook time is more than 20 minutes, no flavour transfer when cooking different foods at the same time, less energy, and shorter cook times. Good for all types of food.</p>	 <p>ECO: The combination of the grill, fan and lower element is particularly suitable for cooking small quantities of food.</p>
 <p>Grill element: Using of grill gives excellent results when cooking meat of medium and small portions, especially when combined with a rotisserie (where possible). Also ideal for cooking sausages and bacon.</p>	 <p>Light</p>
 <p>All glass inner door: All glass inner door, a single flat surface which is simple to keep clean.</p>	 <p>The inner door glass: can be removed with a few quick movements for cleaning.</p>
 <p>Side lights: Two opposing side lights increase visibility inside the oven.</p>	 <p>Warming up: An option for dish warming and keeping the prepared meals hot.</p>
 <p>The oven cavity has 2 different cooking levels.</p>	 <p>The oven cavity has 4 different cooking levels.</p>
 <p>The oven cavity has 9 different cooking levels.</p>	 <p>Telescopic rails: allow you to pull out the dish and check it without having to remove it from the oven entirely.</p>



Electronic control: Allows you to maintain temperature inside the oven with the precision 2-3 ° C. This enables to cook meals that are very sensitive to temperature changes, such as cakes, souffles, puddings.



Tilting grill: the tilting grill can be easily unhooked to move the heating element and clean the roof of the appliance in one simple step.



Ultra rapid burners: Powerful ultra rapid burners offer up to 5kw of power.



Vapor Clean: a simple cleaning function using steam to loosen deposits in the oven cavity.



The capacity indicates the amount of usable space in the oven cavity in litres.



The capacity indicates the amount of usable space in the oven cavity in litres.



The capacity indicates the amount of usable space in the oven cavity in litres.