

TR93IP2

Cooker size	90x60 cm
N. of cavities with energy label	2
Cavity heat source	Electric
Hob type	Induction
Type of main oven	Thermo-ventilated
Type of second oven	Thermo-ventilated
Cleaning system main oven	Vapor Clean
EAN code	8017709312381
Energy efficiency class	A
Energy efficiency class, second cavity	B



Aesthetics

Aesthetics	Victoria	Display	electronic 5 buttons
Colour	Cream	Colour of buttons	Black
Finishing	Gloss	No. of controls	9
Design	Victoria	Serigraphy colour	Black
Door	With frame	Handle	Smeg Victoria
Upstand	Yes	Handle Colour	Brushed stainless steel
Hob colour	Black enamel	Glass type	Black
Command panel finish	Enamelled metal	Plinth	Anthracite
Control knobs	Smeg Victoria	Logo	assembled 50's
Controls colour	Stainless steel	Logo position	Upstand+ Command panel

Programs / Functions

No. of cooking functions 5

Traditional cooking functions



Static



Fan assisted



Circulaire



ECO



Fan assisted base

Cleaning functions



Vapor Clean

Other functions



Defrost by time

Programs / Functions Auxiliary Oven

Cooking functions cavity 2 1
 Traditional cooking functions, cavity 2

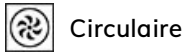

Programme / Functions Third Oven

No. of functions third oven 1
 Oven light 
 Full grill 

Hob technical features



Total no. of cook zones 5

Front left - Induction - single - 2.30 kW - Booster 3.00 kW - - Ø 21.0 cm

Rear left - Induction - single - 1.40 kW - - Ø 18.0 cm

Central - Induction - single - 2.30 kW - Booster 3.00 kW - - Ø 27.0 cm

Rear right - Induction - single - 1.40 kW - - Ø 18.0 cm

Front right - Induction - single - 2.30 kW - Booster 3.00 kW - - Ø 21.0 cm

Automatic switch off when overheat	Yes	Minimum pan diameter indication	Yes
Automatic pan detection	Yes	Selected zone indicator	Yes

Main Oven Technical Features



No. of lights	1	Removable inner door	Yes
Fan number	1	Total no. of door glasses	3
Net volume of the cavity	61 litres	No. of thermo-reflective door glasses	1
Gross volume, 1st cavity	70 l	Safety Thermostat	Yes
Cavity material	Easy clean enamel	Cooling system	Tangential
Shelf positions	4	Usable cavity space dimensions (HxWxD)	316x460x412 mm
Type of shelves	Metal racks	Temperature control	Electro-mechanical
Light type	Halogen	Lower heating element power	1200 W
Light power	40 W	Upper heating element - Power	1000 W
Cooking time setting	Start and Stop	Grill element	1700 W
Door opening	Side opening		
Side opening door	Yes		
Removable door	Yes		

Full glass inner door	Yes	Large grill - Power	2700 W
		Circular heating element - Power	2000 W
		Grill type	Electric
		Tilting grill	Yes

Options Main Oven

Timer	Yes	Minimum Temperature	50 °C
End of cooking acoustic alarm	Yes	Maximum temperature	245 °C

Second Oven Technical Features



Fan number	1	Removable door	Yes
Net volume of the second cavity	62 litres	Full glass inner door	Yes
Gross volume, 2nd cavity	69 l	Removable inner door	Yes
Cavity material	Easy clean enamel	No. total door glasses	1
Shelf positions	9	No. thermo-reflective door glasses	1
Type of shelves	Metal racks	Safety Thermostat	Yes
No. of lights	1	Cooling system	Tangential
Light type	Halogen	Usable cavity space dimensions (HxWxD)	605x275x370 mm
Light power	40 W	Temperature control	Electro-mechanical
Door opening	Side opening	Circular heating element - Power	2500 W
Side opening door	Yes		

Options Auxiliary Oven

Minimum Temperature	50 °C	Maximum temperature	245 °C
---------------------	-------	---------------------	--------

Third Oven Technical Features



Net volume, 3rd cavity	36 l	Removable inner door	Yes
Gross volume, 3rd cavity	41 l	No. total door glasses	3
Cavity material	Easy clean enamel	No. of thermo-reflective door glasses	1
Shelf positions	2	Safety Thermostat	Yes
Type of shelves	Metal racks	Cooling system	Tangential
No. of lights	1	Usable cavity space dimensions (HxWxD)	169x440x443 mm
Light type	Halogen	Temperature control	Electro-mechanical
Light power	40 W	Large grill - Power	2700 W
Door opening	Flap down	Grill type	Electric
Removable door	Yes		

Full glass inner door Yes

Tilting grill Yes

Options Third Oven

Minimum Temperature 50 °C

Maximum temperature 260 °C

Accessories included for Main Oven & Hob



Rack with back and side stop
40mm deep tray 2
1

Grill mesh 1
Telescopic Guide rails, partial Extraction 1

Accessories included for Secondary Oven



Chrome shelf with back stop 4

Plate rack/warmer 1

Accessories included for Third Oven

40mm deep tray 1

Electrical Connection

Nominal power 15000 W

Frequency 50 Hz

Current 42 A

Power supply cable length 150 cm

Voltage 220-240 V

Terminal block

Voltage 2 (V) 380-415 V

5 poles

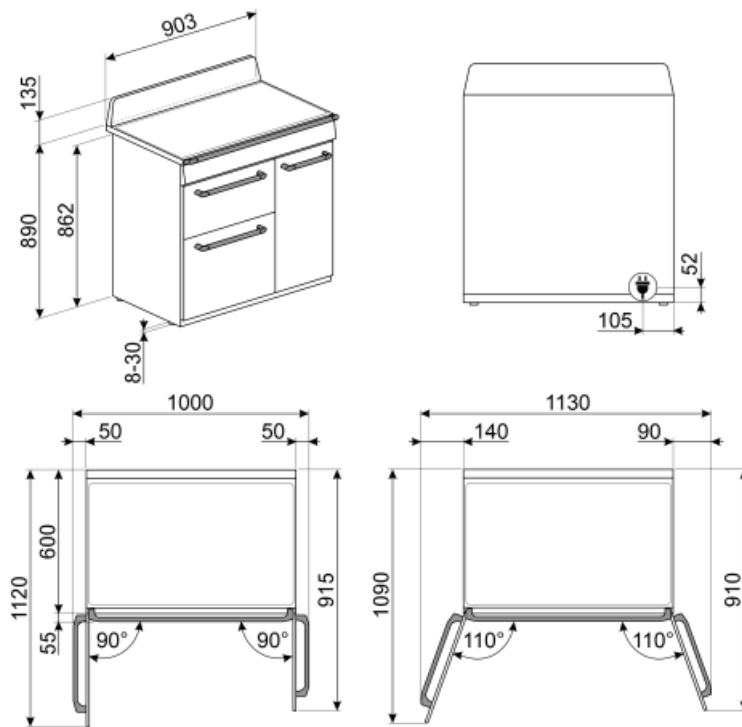

Not included accessories



KIT600TR93

Cover strip for hob back side, suitable for TR93 Victoria cookers



KITP65TR93

Depth extension kit (650 mm), suitable for TR93 cookers



GTP

Partially extractable telescopic guides (1 level) Extraction: 300 mm Material: Stainless steel AISI 430 polished



BNP608T

Teflon-coated tray, 8mm depth, to be placed on the grid



KIT1TR9N

Splashback, 90x75 cm suitable for TR9 Victoria cookers, black



SCRP

Induction and ceramic hobs and teppanyaki scraper



GT1P-2

Partially extractable telescopic guides (1 level) for ovens with metal frames. Length: 355.5 mm, extraction: 285 mm. Material: Stainless steel AISI 430 polished.

BBQ

Double sided plate BBQ. Suitable for recreating succulent and crispy dishes in the oven with the typical taste of grilled cooking. The ribbed side is particularly suitable for meats and cheeses. The smooth side for fish, seafood and vegetables.



AIRFRY

Air fryer rack AIRFRY . Ideal for recreating traditional frying in the oven, but with fewer calories and less fat. It allows you to cook quickly and simply dishes such as French fries, fried vegetables and fish, ensuring perfect browning and crispiness.



SFLK1

Child lock



PRTX

Refractory pizza stone with handles. D=35cm Not suitable for microwave ovens. Suitable for gas ovens, to be put on the griddle.



GRILLPLATE

Universal griddle for induction, gas, ceramic and electric hobs. Non-stick surface ideal for cooking meat, cheese and vegetables. Dimensions: 410 x 240 mm.



BN620-1

Enamelled tray, 20mm deep



KITH93

Height extension kit (950 mm), suitable for TR93 cookers



KIT1TR9X

Splashback, 90x75 cm suitable for TR9 Victoria cookers, stainless steel



TPKPLATE

Universal plate for induction, gas, ceramic and electric hobs. Non-stick surface ideal for cooking fish, eggs and vegetables. Dimensions: 410 X 240 mm.

PALPZ



Pizza shovel with fold away handle
width: 315mm length : 325mm

GTT



****Totally extractable telescopic guides (1 level)**** Extraction: 433 mm
Material: Stainless steel AISI 430 polished

BN640







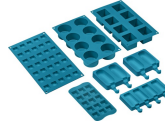



















Enamelled tray, 40mm deep







SMOLD



Set of 7 silicone moulds for ice creams, ice lollies, pralines, ice cubes or to portion food. Usable from -60°C to +230°C

Symbols glossary

 <p>Child lock: some models are fitted with a device to lock the programme/cycle so it cannot be accidentally changed.</p>	 <p>Air cooling system: to ensure a safe surface temperatures.</p>
 <p>A: Product drying performance, measured from A+++ to D / G depending on the product family</p>	 <p>Defrost by time: with this function the time of thawing of foods are determined automatically.</p>
 <p>Triple glazed doors: Number of glazed doors.</p>	 <p>ECO-logic: option allows you to restrict the power limit of the appliance real energy saving.</p>
 <p>B: Product energy rating, measured from A+++ to D / G depending on the product family.</p>	 <p>Enamel interior: The enamel interior of all Smeg ovens have a special antacid lining which helps keep the interior clean by reducing the amount of cooking grease adhering to it.</p>
 <p>Circogas: In gas ovens the fan distributes the heat quickly and evenly throughout the oven cavity, avoiding flavour transfer when cooking a number of different dishes at the same time. In electric ovens this combination completes cooking more quickly of foods that are ready on the surface, but that require more cooking inside, without further browning.</p>	 <p>Fan with upper and lower elements: The elements combined with the fan aim to provide more uniform heat, a similar method to conventional cooking, so pre-heat is required. Most suitable for items requiring slow cooking methods.</p>
 <p>Upper and lower element only: a traditional cooking method best suited for single items located in the centre of the oven. the top pf the oven will always be hottest. Ideal for roast, fruit cakes, bread etc.</p>	 <p>Circulaire: The combination of the fan and circular element around it gives a hot air cooking method. This provides many benefits including no preheat if cook time is more than 20 minutes, no flavour transfer when cooking different foods at the same time, less energy, and shorter cook times. Good for all types of food.</p>
 <p>ECO: The combination of the grill, fan and lower element is particularly suitable for cooking small quantities of food.</p>	 <p>Grill element: Using of grill gives excellent results when cooking meat of medium and small portions, especially when combined with a rotisserie (where possible). Also ideal for cooking sausages and bacon.</p>
 <p>Light</p>	 <p>Overheat protection: The safety system that automatically turns off the hob in case of overheating of the control unit.</p>
 <p>Induction: The work of these hobs is based on the principle of electromagnetic induction. The heat is generated directly in the bottom of the pan during its contact with the hob.</p>	 <p>All glass inner door: All glass inner door, a single flat surface which is simple to keep clean.</p>
 <p>The inner door glass: can be removed with a few quick movements for cleaning.</p>	 <p>Side lights: Two opposing side lights increase visibility inside the oven.</p>
 <p>Warming up: An option for dish warming and keeping the prepared meals hot.</p>	 <p>The oven cavity has 2 different cooking levels.</p>
 <p>The oven cavity has 4 different cooking levels.</p>	 <p>The oven cavity has 9 different cooking levels.</p>

-
- | | |
|---|---|
|  <p>Telescopic rails: allow you to pull out the dish and check it without having to remove it from the oven entirely.</p> |  <p>Electronic control: Allows you to maintain temperature inside the oven with the precision 2-3 ° C. This enables to cook meals that are very sensitive to temperature changes, such as cakes, souffles, puddings.</p> |
|  <p>Tilting grill: the tilting grill can be easily unhooked to move the heating element and clean the roof of the appliance in one simple step.</p> |  <p>Vapor Clean: a simple cleaning function using steam to loosen deposits in the oven cavity.</p> |
|  <p>The capacity indicates the amount of usable space in the oven cavity in litres.</p> |  <p>The capacity indicates the amount of usable space in the oven cavity in litres.</p> |
|  <p>The capacity indicates the amount of usable space in the oven cavity in litres.</p> | |