

# TR90IGR

Cooker size	90x60 cm
N. of cavities with energy label	1
Cavity heat source	Electric
Hob type	Induction
Type of main oven	Thermo-ventilated
Cleaning system main oven	Vapor Clean
EAN code	8017709306663
Energy efficiency class	A



## Aesthetics

<b>Aesthetics</b>	Victoria	<b>No. of controls</b>	7
<b>Colour</b>	Slate Grey	<b>Serigraphy colour</b>	Silver
<b>Design</b>	Victoria	<b>Handle</b>	Smeg Victoria
<b>Door</b>	With frame	<b>Handle Colour</b>	Polished chrome
<b>Upstand</b>	Yes	<b>Glass type</b>	Black
<b>Hob colour</b>	Black enamel	<b>Feet</b>	none
<b>Command panel finish</b>	Enamelled metal	<b>Plinth</b>	Anthracite
<b>Control knobs</b>	Smeg Victoria	<b>Storage compartment</b>	Drawer
<b>Controls colour</b>	Stainless steel	<b>Sliding compartment</b>	Yes
<b>Display</b>	electronic 5 buttons	<b>Logo</b>	assembled 50's
<b>Colour of buttons</b>	Black	<b>Logo position</b>	Upstand+ Command panel

## Programs / Functions

**No. of cooking functions** 9

**Traditional cooking functions**



Static



Fan assisted



Circulaire



ECO



Large grill



Fan grill (large)



Base



Fan assisted base



Rotisserie

**Cleaning functions**

Catalytic



Vapor Clean

## Other functions

 Defrost by time

## Hob options



Control lock Yes

## Hob technical features



**Total no. of cook zones** 5

Front left - Induction - single - 1.30 kW - Booster 1.40 kW - Ø 18.0 cm

Rear left - Induction - single - 2.30 kW - Booster 3.00 kW - Ø 21.0 cm

Central - Induction - single - 2.30 kW - Booster 3.00 kW - Ø 27.0 cm

Rear right - Induction - single - 1.30 kW - Booster 1.40 kW - Ø 18.0 cm

Front right - Induction - single - 2.30 kW - Booster 3.00 kW - Ø 21.0 cm

**Automatic switch off when overheat** Yes **Minimum pan diameter indication** Yes

**Automatic pan detection** Yes **Selected zone indicator** Yes

## Main Oven Technical Features



**No. of lights** 2

**Fan number** 2

**Net volume of the cavity** 115 litres

**Gross volume, 1st cavity** 129 l

**Cavity material** Easy clean enamel

**Shelf positions** 5

**Type of shelves** Metal racks

**Light type** Halogen

**Light power** 40 W

**Cooking time setting** Start and Stop

**Light when oven door is open** Yes

**Door opening** Flap down

**Removable door** Yes

**Full glass inner door** Yes

**Removable inner door** Yes

**Total no. of door glasses** 3

**No. of thermo-reflective door glasses** 2

**Safety Thermostat** Yes

**Cooling system** Tangential

**Usable cavity space dimensions (HxWxD)** 371x724x418 mm

**Temperature control** Electro-mechanical

**Lower heating element power** 1700 W

**Upper heating element - Power** 1200 W

**Grill element** 1700 W

**Large grill - Power** 2900 W

**Circular heating element - Power** 2 x 1550 W

**Grill type** Electric

**Tilting grill** Yes

**Soft Close system** Yes

## Options Main Oven

Timer	Yes	Minimum Temperature	50 °C
End of cooking acoustic alarm	Yes	Maximum temperature	260 °C

## Accessories included for Main Oven & Hob

Rack with back and side stop	1	Grill mesh	1
20mm deep tray	1	Catalytic panels	3
40mm deep tray	1		

## Electrical Connection

Nominal power	14300 W	Frequency	50/60 Hz
Current	42 A	Power supply cable length	150 cm
Voltage	220-240 V	Terminal block	5 poles
Voltage 2 (V)	380-415 V		

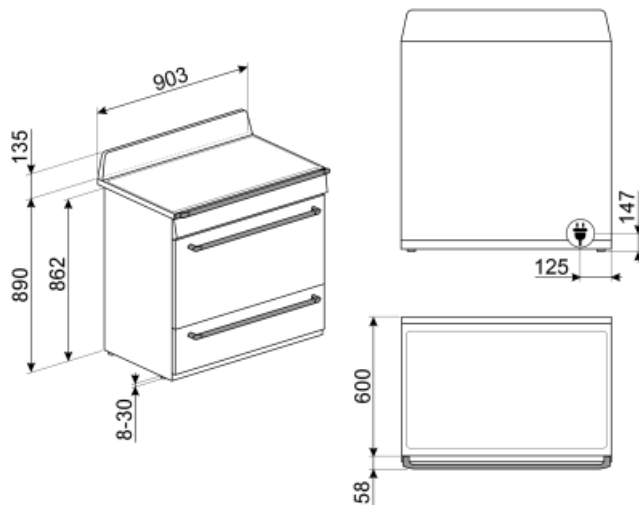

## Not included accessories

### GTP

\*\*Partially extractable telescopic guides (1 level)\*\* Extraction: 300 mm Material: Stainless steel AISI 430 polished



### GRILLPLATE

Universal griddle for induction, gas, ceramic and electric hobs. Non-stick surface ideal for cooking meat, cheese and vegetables. Dimensions: 410 x 240 mm.



### KIT1TR9N

Splashback, 90x75 cm suitable for TR9 Victoria cookers, black



### SCRP

Induction and ceramic hobs and teppanyaki scraper



### KITHTR90

Height extension kit (950 mm), suitable for Victoria TR90 cookers



### TPKPLATE

Universal plate for induction, gas, ceramic and electric hobs. Non-stick surface ideal for cooking fish, eggs and vegetables. Dimensions: 410 X 240 mm.



### GTT

\*\*Totally extractable telescopic guides (1 level)\*\* Extraction: 433 mm Material: Stainless steel AISI 430 polished



### PRTX

Refractory pizza stone with handles. D=35cm Not suitable for microwave ovens. Suitable for gas ovens, to be put on the griddle.

### PPR9

Refractory pizza stone without handles. Squared shaped stone: L64xH2,3xP37,5 cm Suitable also for gas ovens, to be put on the griddle.



### KITROT9

Rotisserie kit for 90x60 cookers, new cavity (115 L)



### GT1P-2

Partially extractable telescopic guides (1 level) for ovens with metal frames. Length: 355.5 mm, extraction: 285 mm. Material: Stainless steel AISI 430 polished.



### KIT1TR9X

Splashback, 90x75 cm suitable for TR9 Victoria cookers, stainless steel



### PALPZ

Pizza shovel with fold away handle width: 315mm length : 325mm







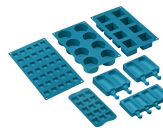



















### SMOLD

Set of 7 silicone moulds for ice creams, ice lollies, pralines, ice cubes or to portion food. Usable from -60°C to +230°C



## Symbols glossary

 <p>A: Product drying performance, measured from A+++ to D / G depending on the product family</p>	 <p>Child lock: some models are fitted with a device to lock the programme/cycle so it cannot be accidentally changed.</p>
 <p>Air cooling system: to ensure a safe surface temperatures.</p>	 <p>Defrost by time: with this function the time of thawing of foods are determined automatically.</p>
 <p>Triple glazed doors: Number of glazed doors.</p>	 <p>Enamel interior: The enamel interior of all Smeg ovens have a special antacid lining which helps keep the interior clean by reducing the amount of cooking grease adhering to it.</p>
 <p>Circogas: In gas ovens the fan distributes the heat quickly and evenly throughout the oven cavity, avoiding flavour transfer when cooking a number of different dishes at the same time. In electric ovens this combination completes cooking more quickly of foods that are ready on the surface, but that require more cooking inside, without further browning.</p>	 <p>Fan with upper and lower elements: The elements combined with the fan aim to provide more uniform heat, a similar method to conventional cooking, so pre-heat is required. Most suitable for items requiring slow cooking methods.</p>
 <p>Upper and lower element only: a traditional cooking method best suited for single items located in the centre of the oven. the top pf the oven will always be hottest. Ideal for roast, fruit cakes, bread etc.</p>	 <p>Lower heating element only: This function is ideal for foods that require extra base temperature without browning, e.g. pastry dishes, pizza. Also suitable for slow cooking of stews and casseroles.</p>
 <p>Circulaire: The combination of the fan and circular element around it gives a hot air cooking method. This provides many benefits including no preheat if cook time is more than 20 minutes, no flavour transfer when cooking different foods at the same time, less energy, and shorter cook times. Good for all types of food.</p>	 <p>ECO: The combination of the grill, fan and lower element is particularly suitable for cooking small quantities of food.</p>
 <p>Grill element: Using of grill gives excellent results when cooking meat of medium and small portions, especially when combined with a rotisserie (where possible). Also ideal for cooking sausages and bacon.</p>	 <p>Fan with grill element: The fan reduces the fierce heat from the grill, providing an excellent method of grilling various foods, chops, steaks, sausages etc. giving even browning and heat distribution, without drying out the food. The top two levels recommended for use, and the lower part of the oven can be used to keep items warm at the same time, an excellent facility when cooking a grilled breakfast. Half grill (centre portion only) is ideal for small quantities of food.</p>
 <p>Rotisserie: The rotisserie (where installed) works in combination with the grill element to brown foods to perfection.</p>	 <p>Overheat protection: The safety system that automatically turns off the hob in case of overheating of the control unit.</p>
 <p>Induction: The work of these hobs is based on the principle of electromagnetic induction. The heat is generated directly in the bottom of the pan during its contact with the hob.</p>	 <p>All glass inner door: All glass inner door, a single flat surface which is simple to keep clean.</p>

-  The inner door glass: can be removed with a few quick movements for cleaning.
-  The oven cavity has 5 different cooking levels.
-  Tilting grill: the tilting grill can be easily unhooked to move the heating element and clean the roof of the appliance in one simple step.
-  The capacity indicates the amount of usable space in the oven cavity in litres.
-  Side lights: Two opposing side lights increase visibility inside the oven.
-  Soft close: all models are equipped with advanced function of smooth closing of the door, which allows the device to close smoothly and quietly.
-  Vapor Clean: a simple cleaning function using steam to loosen deposits in the oven cavity.