

LC53532

EN User Manual | **Washing Machine**



Welcome to AEG! Thank you for choosing our appliance.



Get usage advice, brochures, trouble shooter, service and repair information:
www.aeg.com/support

Subject to change without notice.

CONTENTS

1. SAFETY INFORMATION.....	2
2. SAFETY INSTRUCTIONS.....	4
3. PRODUCT DESCRIPTION.....	6
4. TECHNICAL DATA.....	7
5. INSTALLATION.....	7
6. CONTROL PANEL.....	11
7. DIAL AND BUTTONS.....	11
8. PROGRAMME CHART.....	13
9. BEFORE FIRST USE.....	15
10. DAILY USE.....	15
11. HINTS AND TIPS.....	18
12. CARE AND CLEANING.....	20
13. TROUBLESHOOTING.....	23
14. CONSUMPTION VALUES.....	25
15. ENVIRONMENTAL CONCERNS.....	26

1. ⚠ SAFETY INFORMATION



Before beginning the installation and use of this appliance, carefully read the supplied instructions. The manufacturer is not responsible for any injuries or damage that are the result of incorrect installation or usage. Always keep the instructions in a safe and accessible location for future reference.

1.1 Children and vulnerable people safety

- This appliance can be used by children aged from 8 years and above and persons with reduced physical, sensory or mental capabilities or lack of experience and knowledge if they have been given supervision or instruction concerning the use of the appliance in a safe way and understand the hazards involved.

- Children between 3 and 8 years of age and persons with very extensive and complex disabilities shall be kept away from the appliance unless continuously supervised.
- Children of less than 3 years of age should be kept away from the appliance unless continuously supervised.
- Children should be supervised to ensure that they do not play with the appliance.
- Keep all packaging away from children and dispose of it appropriately.
- Keep detergents away from children.
- Keep children and pets away from the appliance when the door is open.
- If the appliance has a child safety device, it should be activated.
- Children shall not carry out cleaning and user maintenance of the appliance without supervision.

1.2 General Safety

- This appliance is for washing domestic-type, machine-washable laundry only.
- This appliance is designed for single household domestic use in an indoor environment.
- This appliance may be used in, offices, hotel guest rooms, bed & breakfast guest rooms, farm guest houses and other similar accommodation where such use does not exceed (average) domestic usage levels.
- Do not change the specification of this appliance.
- The appliance maximum load is 3 kg. Do not exceed the maximum load of each programme (refer to the “Programmes” chapter).
- The operating water pressure at the water entry point from the outlet connection must be between 0.5 bar (0.05 MPa) and 10 bar (1.0 MPa).
- The ventilation opening in the base must not be covered by a carpet, mat, or any floor covering.

- The appliance must be connected to the water mains using the new supplied hose sets, or other new hose sets supplied by the Authorised Service Centre.
- Old hose sets must not be reused.
- If the mains power supply cable is damaged, it must be replaced by the manufacturer, its Authorised Service Centre or similarly qualified persons to avoid an electrical hazard.
- Before any maintenance operation, deactivate the appliance and disconnect the mains plug from the socket.
- Do not use high pressure water sprays and/or steam to clean the appliance.
- Clean the appliance with a moist cloth. Use only neutral detergents. Do not use abrasive products, abrasive cleaning pads, solvents or metal objects.

2. SAFETY INSTRUCTIONS

2.1 Installation



The installation must comply with relevant national regulations.

- Remove all the packaging and the transit bolts including rubber bush with plastic spacer.
- Keep the transit bolts in a safe place. If the appliance is to be moved in the future they must be reattached to lock the drum to prevent an internal damage.
- Always take care when moving the appliance as it is heavy. Always use safety gloves and enclosed footwear.
- Follow the installation instructions supplied with the appliance.
- Do not install or use a damaged appliance.
- Do not install or use the appliance where the temperature can be less than 0°C or where it is exposed to the weather.
- The floor area on which the appliance is to be installed must be flat, stable, heat resistant and clean.
- Make sure that there is air circulation between the appliance and the floor.

- When the appliance is in its permanent position, check if it is levelled correctly with the aid of a spirit level. If it is not, adjust the feet accordingly.
- Do not install the appliance directly above a floor drain.
- Do not spray water on the appliance and do not expose it to excessive humidity.
- Do not install the appliance where the appliance door cannot be fully opened.
- Do not put a closed container to collect possible water leakage under the appliance. Contact the Authorised Service Centre to ensure which accessories can be used.

2.2 Electrical connection

WARNING!

Risk of fire and electric shock.

- **WARNING:** This appliance is designed to be installed / connected to a grounding connection in the building.
- Always use a correctly installed shockproof socket.
- Make sure that the parameters on the rating plate are compatible with the

electrical ratings of the mains power supply.

- Do not use multi-plug adapters and extension cables.
- Make sure not to cause damage to the mains plug and to the mains cable. Should the mains cable need to be replaced, this must be carried out by our Authorised Service Centre.
- Connect the mains plug to the mains socket only at the end of the installation. Make sure that there is access to the mains plug after the installation.
- Do not touch the mains cable or the mains plug with wet hands.
- Do not pull the mains cable to disconnect the appliance. Always pull the mains plug.
- This appliance is fitted with a 13 A mains plug. If it is necessary to change the mains plug fuse, use only a 13 A ASTA (BS 1362) fuse (UK and Ireland only).

2.3 Water connection

- The inlet water shall not exceed 25 °C.
- Do not cause damage to the water hoses.
- Before connection to new pipes, pipes not used for a long time, where repair work has been carried out or new devices fitted (water meters, etc.), let the water flow until it is clean and clear.
- Ensure that there are no visible water leaks during and after the first use of the appliance.
- Do not use an extension hose if the inlet hose is too short. Contact the Authorised Service Centre for the replacement of the inlet hose.
- When unpacking the appliance, It is possible to see water flowing from the drain hose. This is due to the testing of the appliance with the use of water in the factory.
- You can extend the drain hose to maximum 400 cm. Contact the Authorised Service Centre for the other drain hose and the extension.
- Make sure that there is access to the tap after the installation.

2.4 Use



WARNING!

Risk of injury, electric shock, fire, burns or damage to the appliance.

- Follow the safety instructions on the detergent packaging.
- Do not put flammable products or items that are wet with flammable products in, near or on the appliance.
- Do not wash fabrics which are heavily soiled with oil, grease or other greasy substances. It can damage rubber parts of the washing machine. Prewash such fabrics by hand before loading them into the washing machine.
- Do not touch the glass door while a programme operates. The glass can get hot.
- Make sure that all metal objects are removed from the laundry.

2.5 Service

- To repair the appliance contact the Authorised Service Centre. Use original spare parts only.
- Please note that self-repair or non-professional repair can have safety consequences and might void the guarantee.
- The following spare parts are available for at least 10 years after the model has been discontinued: motor and motor brushes, transmission between motor and drum, pumps, shock absorbers and springs, washing drum, drum spider and related ball bearings, heaters and heating elements, including heat pumps, piping and related equipment including hoses, valves, filters and aquastops, printed circuit boards, electronic displays, pressure switches, thermostats and sensors, software and firmware including reset software, door, door hinge and seals, other seals, door locking assembly, plastic peripherals such as detergent dispensers. The duration may be longer in your country. For further information, please visit our website.
- Please note that some of these spare parts are only available to professional

repairers, and that not all spare parts are relevant for all models.

- Concerning the lamp(s) inside this product and spare part lamps sold separately: These lamps are intended to withstand extreme physical conditions in household appliances, such as temperature, vibration, humidity, or are intended to signal information about the operational status of the appliance. They are not intended to be used in other applications and are not suitable for household room illumination.

2.6 Disposal

⚠ WARNING!

Risk of injury or suffocation.

- Disconnect the appliance from the mains electrical and water supplies.
- Cut off the mains electrical cable close to the appliance and dispose of it.
- Remove the door catch to prevent children or pets from becoming trapped in the drum.
- Dispose of the appliance in accordance with local requirements for the disposal of Waste Electrical and Electronic Equipment (WEEE).

3. PRODUCT DESCRIPTION

3.1 Appliance overview

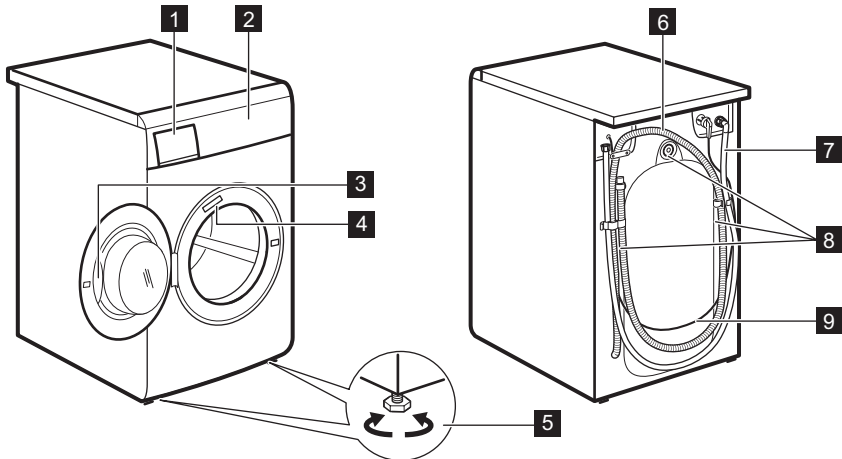

- 1** Detergent dispenser drawer
- 2** Control panel
- 3** Door handle
- 4** Rating plate
- 5** Feet for levelling the appliance

- 6** Drain hose
- 7** Inlet hose
- 8** Transit bolts
- 9** Mains cable

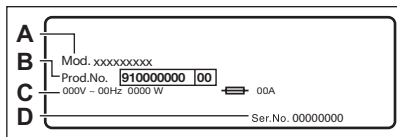

The rating plate reports the model name (A), product number (B), electrical ratings (C) and serial number (D).

4. TECHNICAL DATA

Dimension	Width/ Height/ Total depth	50 cm /67 cm /55 cm
Electrical connection	Voltage Overall power Fuse Frequency	230-240 V 1600 W 13 A 50 Hz
Level of protection against ingress of solid particles and moisture ensured by the protective cover, except where the low voltage equipment has no protection against moisture		IPX4
Water supply pressure 1)	Minimum Maximum	0.5 bar (0.05 MPa) 10 bar (1.0 MPa)
Water supply 2)		Cold water
Maximum Load	Cotton	3 kg
Spin Speed	Maximum spin speed	1251 rpm

1) The appliance works correctly if the water pressure is not lower than 0.05 MPa (0.5 bar). If you cannot connect the water inlet hose to the cold water tap of the primary hydraulic system, connect it to your domestic cold water storage system. Make sure not to exceed a distance of 5.02 m (16.5 ft) between the appliance inlet hose and the bottom of the water storage tank.

2) Connect the water inlet hose to a water tap with a 3/4" thread.

5. INSTALLATION

WARNING!

Refer to Safety chapters.

5.1 Lifting the machine

Incorrect methods of lifting can damage the appliance. Open the door and take hold of the top inside of the door opening. You can also lift the machine by gripping the rear overhang of the top.

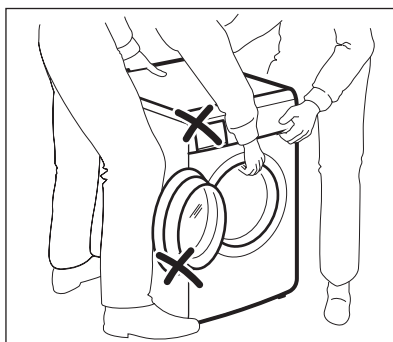

⚠ WARNING!

Never lift the machine by gripping its control panel, door, or detergent dispenser.

5.2 Unpacking

1. Open the door. Remove all items from the drum.
2. Put the packaging element on the floor behind the appliance and carefully put it down onto its rear side. Remove the polystyrene protection from the bottom.

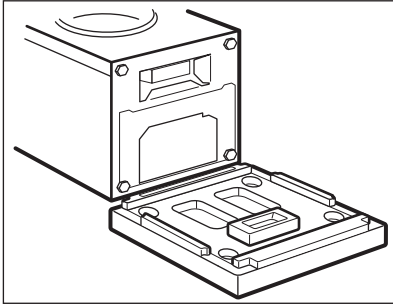

⚠ CAUTION!

Do not lay washing machine on its front.

3. Put the appliance back into an upright position. Remove the power supply cable and the drain hose from the hose holders.

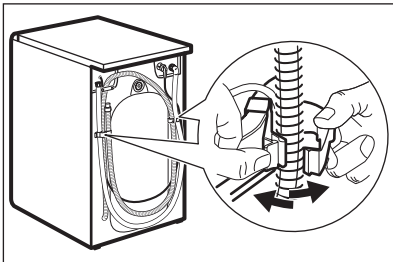

i

It is possible to see water flowing from the drain hose. This is because the washing machine has been tested at the factory.

4. Remove the three transit bolts and pull out the plastic spacers.

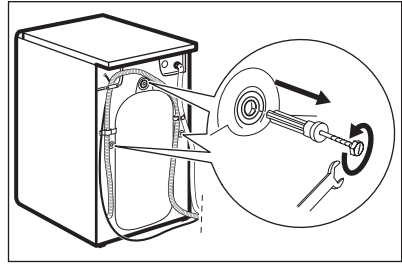

i

We recommend that you keep the packaging and the transit bolts for any transport of the appliance.

5. Put the plastic caps, that you find in the user manual bag, in the holes.

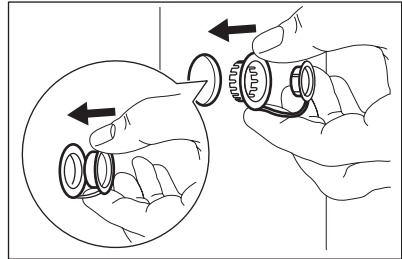

5.3 Information for installation

Positioning and levelling

Adjust the appliance correctly to prevent vibration, noise and movement of the appliance when it operates.

1. Install the appliance on a flat hard floor. The appliance must be levelled and stable. Make sure that the appliance does not touch the wall or other units and there is air circulation below the appliance.
2. Loosen or tighten the feet to adjust the level. All feet must rest firmly on the floor.

⚠ WARNING!

Do not put cardboard, wood or equivalent materials below the appliance feet to adjust the level.

The inlet hose

1. Connect the water inlet hose to the back of the appliance.

2. Position it toward left or right depending on the position of the water tap. Make sure that the inlet hose is not in vertical position.

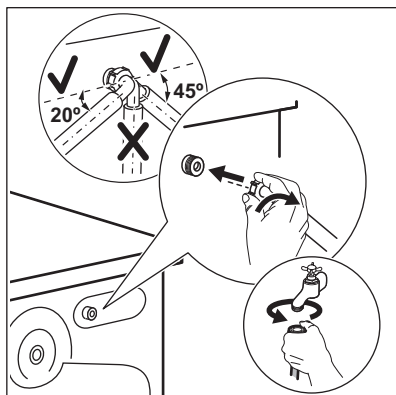

3. If necessary, loosen the ring nut to set it in the correct position.

4. Connect the water inlet hose to the cold water tap with 3/4" thread.

⚠ CAUTION!

Make sure there is no damage to hoses and there are no leaks from the couplings. Do not use an extension hose if the inlet hose is too short. Contact the service centre for a replacement inlet hose.

⚠ WARNING!

The inlet water shall not exceed 25 °C.

5.4 Water drainage

The drain hose should be positioned at a height of not less than 60 cm and not more than 100 cm from the floor.



You can extend the drain hose to maximum 400 cm. Contact the authorized service centre to buy the other drain hose and the extension.

- Connect the drain hose to the spigot and tighten it with a clamp.
- Position the hose directly to a built-in drain pipe in the room wall and tighten it with a clamp.
- Without the plastic hose guide, to a sink spigot - put the drain hose in the spigot and tighten it with a clamp.
- To a stand pipe with vent hole - insert the drain hose directly into a drain pipe or stand pipe.
- The drain hose can be bent into U shape and put around the plastic guide. On the edge of a sink - fasten the guide to the water tap or to the wall.



Make sure that the drain hose makes a loop to prevent particles going into the appliance from the sink.



Make sure that the plastic guide cannot move when the appliance drains and the drain hose end is not immersed in the water. There may be a return of dirty water into the appliance. Buy accessories from authorised supplier.



The end of the drain hose must always be ventilated , i.e. the inner diameter of the drain pipe (min. 38 mm - min. 1.5") must be larger than the external diameter of the drain hose.

It is possible to connect the drain hose in different ways:

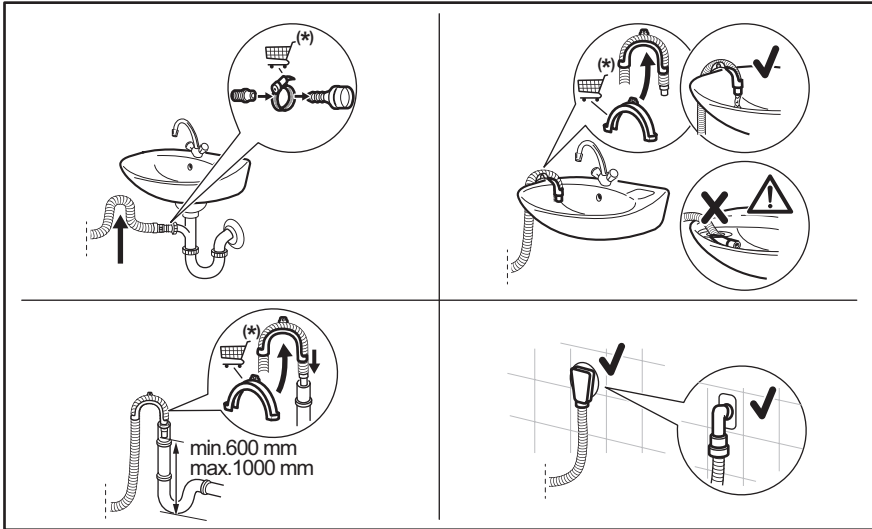

(*) Subject to change without notice.

5.5 Electrical connection

At the end of installation you can connect the mains plug to the mains socket.

The rating plate on the inner edge of the appliance door and the 'Technical Data' chapter indicate the necessary electrical ratings. Make sure that they are compatible with the mains power supply.

Check that your domestic electrical installation can take the maximum load required, also taking into account any other appliances in use.

Connect the appliance to an earthed socket.

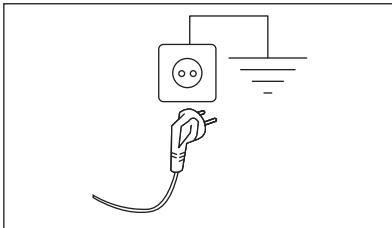

The power supply cable must be easily accessible after installing the appliance.

For any electrical work required to install this appliance, contact our Authorised Service Centre.

The manufacturer does not accept any responsibility for damage or injury through failure to comply with the above safety precaution.

6. CONTROL PANEL

6.1 Control panel description

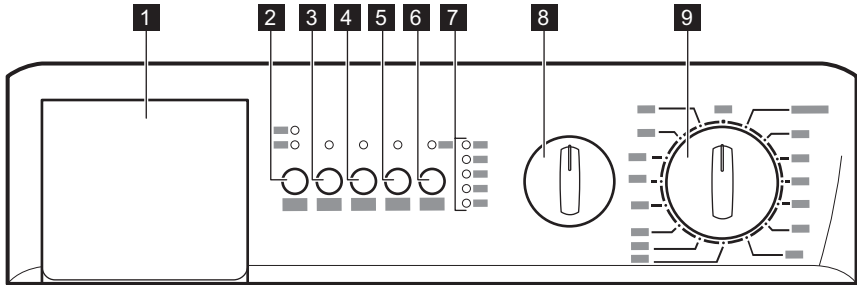

- | | |
|---|--|
| 1 Detergent drawer | 6 Delay Start button |
| 2 Time Save button Extra Quick / Quick | 7 Programme progress indicators |
| 3 Easy Iron button | 8 SPIN reduction selector |
| 4 Prewash button | 9 Programme selector dial |
| 5 Start/Pause button | |

7. DIAL AND BUTTONS

7.1 Introduction



The options/functions are not available with all washing programmes. Check the compatibility between options/functions and washing programmes in the "Programme Chart". An option/function can exclude another one, in this case the appliance doesn't allow you to set incompatible options/functions.

7.2 Programme Selector Dial

Select suitable programme depending on the type, amount and soiling level of the laundry to ensure more effective washing results.

Selector dial also allows you to switch the appliance On and Off.

7.3 Spin Reduction Dial

Change the spin speed by turning the selector knob to the chosen value.

Additional spin options:

- **No Spin 0**
Set this option to deactivate all spin phases. The appliance performs the only draining phase of the selected washing programme. Set this option for very delicate fabrics. The rinses phase uses more water for some washing programmes.
- **Rinse Hold**
The final spin is not performed. The water of the last rinse is not drained out to prevent the fabrics from creasing. The washing programme ends with water in the drum. When the programme has finished, the lights **Spin** and **End** are lit to indicate that the water must be emptied out. Read the "At the end of the programme" paragraph.



For the maximum spin speed allowed by each programme, refer to the "**Programme Chart**" chapter.

7.4 Select the desired options

If desired, set one or more options by touching the related buttons. These must be selected after choosing the programme and before pressing the button Start/Pause . The relevant light will illuminate.

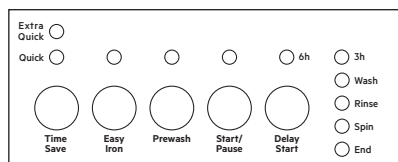

If an incorrect option is selected, the corresponding indicator lamp flashes for about 2 seconds.



For the compatibility of the options with the washing programmes, refer to the chapter "**Programme Chart**".

7.5 Time Save button

This option may be advisable to shorten the washing programme.

Use this option for items with normal or light soil or items to refresh.

Touch this button **once** to decrease the duration.

In case of smaller load, touch this button **twice** to set an extra quick programme.

This option must be selected after you have set the programme and before you press button Start/Pause The relevant indicator illuminates.

- **Extra Quick**
Short programme for normally soiled cotton, synthetic or delicate items. The washing time will be reduced according to the type of fabric and the selected temperature.
- **Quick**
Short programme for lightly soiled white-/coloured and synthetic laundry. The washing time will be reduced approx. 10 minutes. Max. recommended temperature 60°C.



This options can not be chosen together with the programme Eco 40-60 and neither with the wool, delicate or hand wash programmes. The washing time will be reduced depending on the type of material and the selected temperature. Recommended load for cotton is 2 kg.

7.6 Easy Iron

The appliance carefully washes and spins the laundry to prevent the creases.

The appliance decreases the spin speed, uses more water and adapts the programme duration to the type of laundry.

The related indicator comes on.

7.7 Prewash

With this option you can add a prewash phase to a washing programme. The relevant indicator illuminates.

Use this option to add a pre-wash phase before the washing phase.

This option is recommended for heavily soiled laundry, especially if containing sand, dust, mud and other solid particles.



This option can increase the programme duration.

7.8 Start/Pause

This button allows you to start or to interrupt the selected programme.

7.9 Delay Start

The start of the programme can be delayed by 6 or 3 hours by means of this button. The selected delay is indicated by the illumination of the corresponding light.

7.10 Indicators

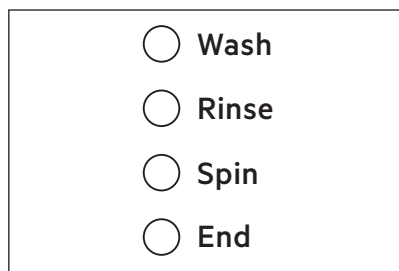

The light **Wash** illuminates when the machine is performing **the washing phase**.



The light **Rinse** illuminates when the machine is **rinsing**.

The light **Spin** illuminates when the machine is **spinning**.

The light **End** illuminates at **the end** of the washing cycle.

- The light is on: the door cannot be opened.
- The light is off: the door can be opened.
- The light is flashing: the door can soon be opened.

8. PROGRAMME CHART

Programme Temperature range	Spin speed range	Maximum load	Programme description (Type of load and level of soiling)
Washing programmes			
Eco 40-60 40 °C 1)	1300 rpm	3 kg	White cotton and fast-coloured cotton. Normally soiled items. The energy consumption decreases and the time of the washing programme is extended, ensuring good washing results.
Cottons  90 - 30 °C	1300 rpm	3 kg	White cotton. Heavily and normally soiled items.
Synthetics  40 - 30 °C	900 rpm	1,5 kg	Synthetic items or mixed fabric items. Normally soiled items.
Delicates  40 °C - Cold	700 rpm	1,5 kg	Delicate fabrics such as acrylics, viscose and mixed fabrics requiring gentler washing. Normally and lightly soiled items.
Wool 30 °C	900 rpm	1 kg	Machine washable wool, hand washable wool and other fabrics with «hand washing» care symbol²⁾.
Mix 20 °C	900 rpm	1,5 kg	Special programme for lightly soiled cotton, synthetic and mixed fabrics. Select this programme to reduce the energy consumption. Make sure that the detergent is suitable for low temperature in order to have good washing results.

Programme Temperature range	Spin speed range	Maxi- mum load	Programme description (Type of load and level of soiling)
Rinse	1300 rpm	3 kg	All fabrics, except woollens and very delicate fabrics. Programme for rinsing and spinning the laundry. The default spin speed is the one used for cotton programmes. Reduce the spin speed according to the type of laundry. If necessary, set the Extra Rinse option to add rinses. With a low spin speed, the appliance performs delicate rinses and a short spin.
Drain	-	3 kg	To drain the water in the drum. All fabrics.
Spin	1300 rpm	3 kg	All fabrics, except woollens and delicate fabrics. To spin the laundry and to drain the water in the drum.



1) According to UK Ecodesign for Energy-Related Products and Energy Information Regulations, this programme at 40 °C is able to clean normally soiled cotton laundry declared to be washable at 40 °C or 60 °C, together in the same cycle.



For the reached temperature in the laundry, the programme duration and other data, please refer to 'Consumption Values' chapter. The most efficient programmes in terms of energy consumption are generally those that perform at lower temperatures and longer duration.

2) During this cycle the drum rotates slowly to ensure a gentle wash. It can seem that the drum doesn't rotate or doesn't rotate properly, but this is normal for this programme.

Programme options compatibility



Programme	Spin	No spin 0	Rinse Hold	Extra Quick	Quick	Easy Iron	Prewash	Delay Start
Eco 40-60	■	■	■					■
Cottons 	■	■	■	■ 1)	■ 1)	■	■	■
Synthetics 	■	■	■	■	■	■	■	■
Delicates 	■	■	■	■			■	■
Wool	■	■	■					■
Mix	■	■	■					■
Rinse	■	■	■			■		■
Drain								

Programme	Spin	No spin 0	Rinse Hold	Extra Quick	Quick	Easy Iron	Prewash	Delay Start
-----------	------	-----------	------------	-------------	-------	-----------	---------	-------------

Spin ■

1) If you select this option, we recommend that you reduce the maximum load. Recommended load for cotton is 2 kg.

Suitable detergents for washing programmes

Programme	Universal powder ¹⁾	Liquid Universal	Liquid for colours	Delicates woollens	Special
Eco 40-60	▲	▲	▲	--	--
Cottons 	▲	▲	▲	--	--
Synthetics 	▲	▲	▲	--	--
Delicates 	--	--	--	▲	▲
Wool	--	--	--	▲	▲
Mix	--	▲	▲	--	--

1) At temperature higher than 60 °C the use of powder detergent is recommended.

▲ = Recommended

-- = Not recommended

9. BEFORE FIRST USE



During installation or before first use you may observe some water in the appliance. This is a residual water left in the appliance after a full functional test in the factory to ensure the appliance is delivered to customers in perfect working order and is no cause for concern.

1. Make sure that all transit bolts have been removed from the appliance.

2. Make sure that the electrical power is available and the water tap is open.
3. Pour small quantity of detergent straight into the drum.
4. Set and start a programme for cotton at the highest temperature without laundry in the drum. This removes all possible dirt from the drum and the tub.

10. DAILY USE



WARNING!

Refer to Safety chapters.

10.1 Loading the laundry

1. Open the appliance door.

2. Shake the items before you put them in the appliance.
3. Put the laundry in the drum, one item at a time.

Make sure not to put too much laundry in the drum.

4. Close the door firmly.

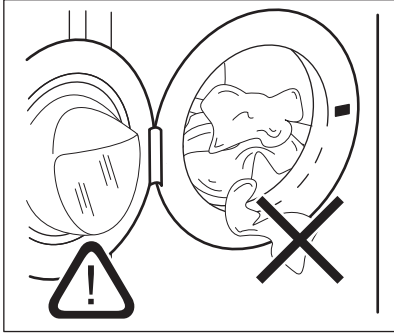

⚠ CAUTION!

Make sure that no laundry stays between the seal and the door. There is a risk of water leakage or damage to the laundry.

⚠ CAUTION!

Washing heavily oiled, greasy stains could cause damage rubber parts of the appliance.

10.2 Filling the detergent and additives

1. Measure out specified detergents and the fabric conditioner.
2. Put the detergent and the fabric conditioner into the proper compartments.



Always follow the instructions that you find on the packaging of the detergent products, but we recommend that you do not exceed the maximum indicated level (**MAX**). This quantity will however guarantee the best washing results.



When you set a programme with prewash, put the detergent for prewash phase directly into the drum.

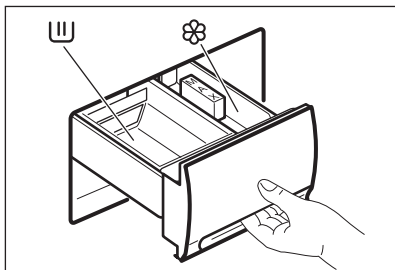

Compartment for powder or liquid detergent used for main wash.

If using liquid detergent, pour it **just before** starting the programme.



Compartment for liquid additives (fabric conditioner, starch).

Additives must be poured into the compartment before starting the wash programme.

Maximum level for quantity of liquid additives.

MAX



After a washing cycle remove any detergent residue from the detergent dispenser.

10.3 Select the required programme by means of the programme selector dial

Turn the programme selector dial to the required programme. The indicator of button Start/Pause flashes. When you activate an

option, the indicator of the set option comes on.



If you turn the programme selector dial to another programme when the machine is working, the lights in the programme progress display will start to flash to indicate a wrong selection. The machine will not perform the new selected programme.

10.4 Starting the programme

1. Turn the programme dial to select the desired washing programme. The indicator of the Start/Pause button flashes.
2. To change the spin speed turn the dial, set one or more options by touching the related buttons.
3. To start the selected programme, press the button Start/Pause . The related indicators come on to indicate that the appliance starts operating and the door is locked.

10.5 Starting a programme with the delay start

To set delay the start option press the button Delay Start repeatedly, to select the desired delay. The indicator of the set delay is on.

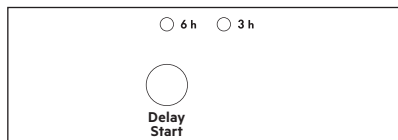

You must select this option after you have set the programme and before you press button Start/Pause . You can cancel or change the set of the delay start before you press the button Start/Pause .

Cancelling the delayed start after having pressed button Start/Pause:

1. Press the button Start/Pause to set appliance to pause.

2. Press the button Delay Start until the indicator of the set delay goes off.
3. Press button Start/Pause to start the programme.



The selected delay can be changed only after selecting the washing programme again. The door will be locked throughout the delay time (door locked indicator is on).

The Delay Start **can not** be selected with Drain or Spin programme.

10.6 Interrupting a programme and changing option

The programme can be changed as long as the button Start/Pause has not been pressed.

Changing a running programme is possible only by resetting it:

1. Turn the programme selector dial to .
2. Select the new programme position and set desired options.
3. Press the button Start/Pause again.

10.7 Cancelling a programme

Turn the selector dial to  position to cancel a programme which is running. Now you can select a new programme.

10.8 Opening the door after the programme operates

Press the button Start/Pause to open the door.

After some minutes, the door can be opened, when the following conditions are observed:

- The water temperature is below 55°C.
- The water level is below the bottom edge of the door.
- The machine doesn't spin.

If you cannot open the door appliance has to be switched off by turning the selector dial to

 After few minutes the door can be opened (**pay attention to the water level and temperature!**).

10.9 Opening the door when the delay start is active

While the delay start operates, the appliance door is locked.

To open the appliance door

1. Press the button Start/Pause .
2. Open the appliance door.
3. Close the door and press button Start/Pause .

The delay start continues.

10.10 At the end of the programme

The machine stops automatically.

The indicator **End** illuminates to indicate that the programme has finished. The indicator

End goes out, the door can be opened and the laundry can be removed.

- select the Drain or Spin programme
- press button Start/Pause

When the pilot light **End** goes out, the door can be opened and the laundry can be removed.

Remove the laundry from the drum and carefully check that the drum is empty. If you do not intend to carry out another wash, close the water tap.

Leave the door open to prevent the formation of mildew and unpleasant smells.

11. HINTS AND TIPS

11.1 The laundry load

- Divide the laundry in: white, coloured, synthetics, delicates and wool.
- Obey the washing instructions that are on the laundry care labels.
- Do not wash white and coloured items together.
- Some coloured items can discolour with the first wash. We recommend that you wash them separately for the first times.
- Turn multilayered fabrics, wool and items with painted illustrations inside out.
- Wash and pre-treat heavy soil stains with a suitable detergent before putting in drum.
- Be careful with the curtains. Remove the hooks and put the curtains in a washing bag or pillowcase.
- Do not wash laundry without hems or with cuts. Use a washing bag to wash small and/or delicate items (e.g. underwired bras, belts, tights, shoelaces, ribbons, etc.).

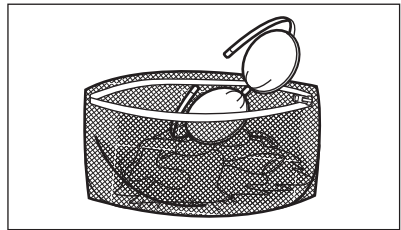

- A very small load can cause balance problems with the spin phase leading to excessive vibration. If this occurs:
 - interrupt the programme and open the door (refer to "Daily Use" chapter);
 - manually redistribute the load so that the items are spaced evenly around the tub;
 - press the Start/Pause button. The spin phase continues.
- Avoid washing garments full of long animal hair or poor quality garments releasing lots of fluff that could block the drain circuit and therefore requiring the Service assistance.
- Button up pillowcases, close zippers, hooks and poppers. Tie up belts, cords, shoelaces, ribbons and any other loose elements.
- Empty the pockets and unfold the items.

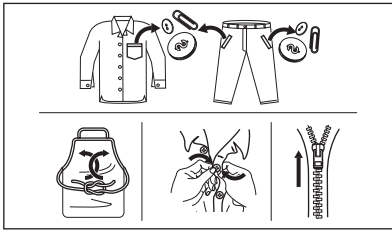

11.2 Stubborn stains

For some stains, water and detergent is not sufficient.

We recommend that you pre-treat these stains before you put the items in the appliance.

Special stain removers are available. Use the special stain remover that is applicable to the type of stain and fabric.

11.3 Detergent type and quantity.

The choice of detergent and use of correct quantities not only affects your wash performance, but also helps to avoid waste and protect the environment:

- Use only detergents and other treatments specially made for washing machines. First, follow these generic rules:
 - powder detergents for all types of fabric, excluding delicate. Prefer powder detergents containing bleach for whites and laundry sanitization,
 - liquid detergents, preferably for low temperature wash programmes (60 °C max) for all types of fabric, or special ones for woollens only.
- The choice and quantity of detergent will depend on: type of fabric (delicates, woollens, cottons, etc), the colour of clothes, size of the load, degree of soiling, wash temperature and hardness of the water used.
- Follow the instructions that you find on packaging of the detergents or other treatments without exceeding the indicated maximum level (**MAX**).
- Do not mix different types of detergents.
- Use less detergent if:
 - you are washing a small load,
 - the laundry is lightly soiled,

– there is large amounts of foam during washing.

- When using detergent tabs or pods, always put them inside the drum, not in the detergent dispenser.

Insufficient detergent may cause:

- unsatisfactory washing results,
- the wash load to turn grey,
- greasy clothes,
- mould in the appliance.

Excessive detergent may cause:

- sudsing,
- reduced washing effect,
- inadequate rinsing,
- a greater impact for the environment.

11.4 Ecological hints

To save water, energy and to help protect the environment, we recommend that you follow these tips:

- **Normally soiled laundry** may be washed **without prewash** in order to save detergent, water and time (the environment is protected too!).
- Loading the appliance to the **maximum capacity indicated for each programmes helps to reduce energy and water consumption.**
- With adequate pre-treatment, stains and limited soiling can be removed; the laundry can then be washed at a lower temperature.
- To use the correct quantity of detergent, refer to the quantity suggested by the detergent producer and check the water hardness of your domestic system. Refer to "Water hardness".
- Set the **maximum possible spin speed** for the selected washing programme **before drying your laundry in a tumble dryer.** This will save energy during drying!

11.5 Water hardness

If the water hardness in your area is high or moderate, we recommend that you use a water softener for washing machines. In areas where the water hardness is soft it is not necessary to use a water softener.

To know the water hardness in your area, contact your local water authority.

Use the correct quantity of the water softener. Obey the instructions that you find on the packaging of the product.

12. CARE AND CLEANING

⚠ WARNING!
Refer to Safety chapters.

12.1 Periodic cleaning schedule

Periodic cleaning helps to extend the life of your appliance.

After each cycle, keep the door and the detergent dispenser slightly ajar to get air circulation and dry the humidity inside the appliance: this will prevent mildew and odours.

If the appliance is not used for a long time: close the water tap and unplug the appliance.

Indicative periodic cleaning schedule:

Descaling	Twice a year
Maintenance wash	Once a month
Clean door seal	Every two months
Clean drum	Every two months
Clean detergent dispenser	Every two months
Clean the inlet hose and the valve filter	Twice a year

The following paragraphs explain how you should clean each part.

12.2 Removing foreign objects

i
Make sure that pockets are empty and all loose elements are tied up before running your cycle. Refer to "The laundry load" in "Hints and tips".

Remove any foreign objects (such as metal clip, buttons, coins, etc) that you may find in the door seal, the inlet hose filter and the drum. Refer to "Door seal with double lip trap", "Cleaning the drum" and "Cleaning the inlet hose and the valve filter" paragraphs. If

necessary, please contact the Authorised Service Centre.

12.3 External cleaning

Clean the appliance with soap and warm water only. Fully dry all the surfaces. Do not use a scouring pads or any scratching material.

⚠ CAUTION!
Do not use alcohol, solvents or chemical products.

⚠ CAUTION!
Do not use the metal surfaces with chlorine-based detergent.

12.4 Descaling

If the water hardness in your area is high or moderate, we recommend that you use a water descaling product for washing machines.

Regularly examine the drum to prevent limescale and rust particles.

To remove rust particles use only special products for washing machines. Do this separately from the laundry wash.

i
Always obey the instructions that you find on the packaging of the product.

12.5 Maintenance wash

With the low temperature programmes it is possible that some detergent stays in the drum. Perform a maintenance wash regularly. To do this:

- Remove all laundry from the drum.
- Select the cotton programme with the highest temperature with a small quantity of detergent.

12.6 Door seal

This appliance allows light fluff fibers that fall off the clothes to be drained out with the water. Regularly examine the seal. Coins, buttons, other small items can be recovered at the end of the cycle.

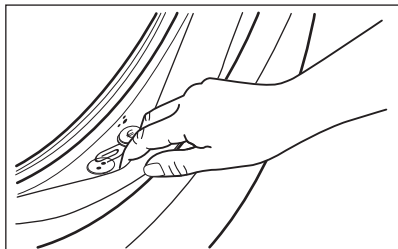

12.7 Cleaning the drum

Regularly examine the drum to prevent unwanted deposits.

Rust deposits in the drum may occur due to rusting foreign body in the washing or tap water containing iron

Clean the drum with special products for stainless steel.



Always follow the instructions that you find on the packaging of the product. Do not clean the drum with acidic descaling products, scouring products containing chlorine or iron or steel wool.

For a thorough clean:

1. Remove all laundry from the drum.
2. Add a small quantity of powder detergent into the empty drum, in order to rinse out any left residues.
3. Run a Cottons  programme with the highest temperature.

12.8 Cleaning the dispenser drawer

To prevent possible deposits of dried detergent or clotted fabric softener and/or formation of mould in the detergent dispenser drawer, once in a while carry out the following cleaning procedure:

1. Pull the drawer firmly outwards, so that it comes free of retaining stop.

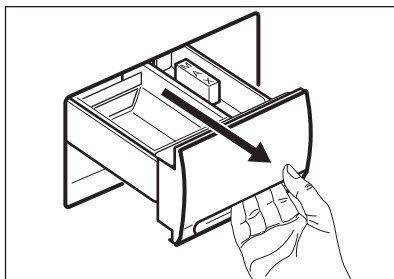

2. To remove the siphon press it inwards and pull it upwards at the same time. Flush both parts out under running warm water to remove any traces of accumulated detergent.

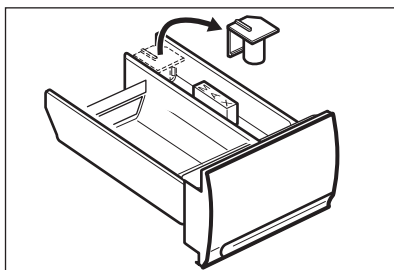

3. Put the siphon back into position by pressing it downwards until you hear a click.
4. Use a small brush to clean the recess. Make sure that all detergent residue is removed from the upper and lower part of the recess.

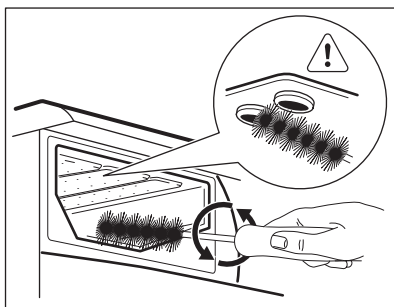

5. Insert the detergent drawer into the guide rails and close it. Run the rinsing programme without any clothes in the drum.

12.9 Cleaning the inlet hose and the valve filter

It is recommended to clean both the filters of the inlet hose and valve occasionally to remove any deposit, collected over the time:

1. Remove the inlet hose from the tap and clean the filter.

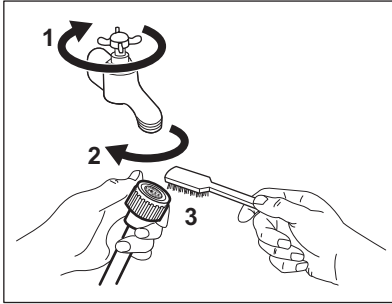

2. Remove the inlet hose from the appliance by loosening the ring nut.

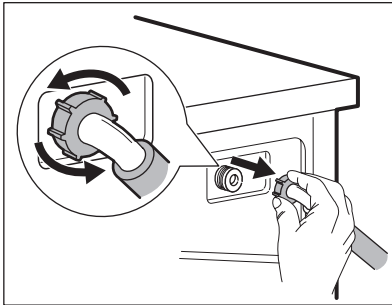

3. Clean the valve filter on the back of the appliance with a toothbrush.

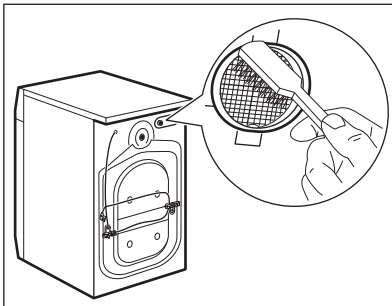

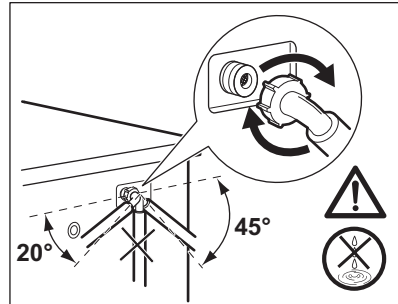

4. When you reconnect the hose to the back of the appliance, turn it left or right (not in vertical position) depending on the position of your water tap.



12.10 The dangers of freezing

If the appliance is installed in an area where the temperature can reach values around 0° C or drop below, remove the remaining water from the inlet hose and the drain pump.

- Close the water tap and unscrew the inlet hose from it.
- Select a wash programme, start the machine and let the programme run for a short time.
- Interrupt the programme by turning the programme selector to  position.
- Put the end of the inlet hose in a container and let the water flow out of the hose.
- Select the programme "Drain" and let it run until it is finished.
- Turn the programme selector to  position. When you intend to start the machine up again, make sure that the room temperature is above 0 °C.

WARNING!

Make sure that the temperature is higher than 0 °C before you use the appliance again.

The manufacturer is not responsible for damages caused by low temperatures.

13. TROUBLESHOOTING

WARNING!

Refer to Safety chapters.

13.1 Introduction

The appliance does not start or it stops during operation. First try to find a solution to the problem (refer to the tables).

WARNING!

Deactivate the appliance before carrying out any check.

With some problems indicator of the **END** of programme blinks:

Problem	Possible cause/Solution
1 flash The appliance does not fill with water properly.	<ul style="list-style-type: none">• Make sure that the water tap is open.• Make sure that the pressure of the water supply is not too low. For this information, contact your local water authority.• Make sure that the inlet hose has no kinks, damages or bends.• Make sure that the water tap is not clogged.• Make sure that the connection of the water inlet hose is correct.• Make sure that the filter of the inlet hose and the filter of the valve are not clogged. Refer to "Care and cleaning".• This problem may be also caused by the clogged drain circuit. Please contact the Authorised Service Centre.
2 flashes The appliance does not drain the water.	<ul style="list-style-type: none">• Make sure that the sink spigot is not clogged.• Make sure that the hoses have no kinks, damages or bends.• Set the drain programme if you set a programme without drain phase.• Set the drain programme if you set an option which ends with water in the tub.• Make sure that the laundry is evenly distributed in the drum.
4 flashes The appliance door is open or not closed correctly.	<ul style="list-style-type: none">• Make sure that the door is properly closed.

Once the problem has been eliminated, press the button Start/Pause to restart the programme. If after all checks, the problem persists, contact your Authorised Service Centre.

13.2 Possible failures

In case of different problem with the washing machine check the table below for possible solutions.

Problem	Possible cause/Solution
The programme does not start.	<ul style="list-style-type: none">• Make sure that the mains plug is connected to the mains socket.• Make sure that the appliance door is closed.• Make sure that there is no damaged fuse in the fuse box.• Make sure that the Start/Pause has been touched.• Check the position of the knob on the selected programme.• If the delay start is set (if available), cancel the setting or wait for the end of countdown.

Problem	Possible cause/Solution
The appliance fills with water then drains immediately.	<ul style="list-style-type: none"> • Make sure that the drain hose is in the correct position. The hose may be positioned too low. Refer to "Installation" chapter.
The spin phase does not operate or the washing cycle lasts longer than usual.	<ul style="list-style-type: none"> • Set the spin programme. • Adjust manually the items in the tub and start the spin phase again. This problem may be caused by balance problems.
You cannot open the appliance door.	<ul style="list-style-type: none"> • Make sure that a washing programme that ends with water in tub, has not been selected. • Set the drain or the spin programme if there is water in the drum. • Make sure that the washing programme is finished. • Wait until the indicator light for door locked has gone out. • Make sure that the appliance receives electrical power. • This problem may be caused by a failure of the appliance. Contact the Authorised Service Centre.
The appliance makes an unusual noise and vibrates.	<ul style="list-style-type: none"> • Make sure that the packaging and/or the transit bolts are removed. Refer to "Installation" chapter. • Make sure the levelling of the appliance is correct. Refer to "Installation" chapter. • Make sure that laundry is evenly distributed. • Add more laundry in the drum. The load may be too small.
There is water on the floor.	<ul style="list-style-type: none"> • Make sure that the couplings of the water hoses are tight and there is not water leakages. • Make sure that the water inlet hose and the drain hose have no damages. • Make sure you use the correct detergent and the correct quantity of it.
The washing results are not satisfactory.	<ul style="list-style-type: none"> • Increase the detergent quantity or use a different detergent. • Use special products to remove the stubborn stains before you wash the laundry. • Make sure that you set the correct temperature. • Decrease the laundry load.
Too much foam in the drum during the washing cycle.	<ul style="list-style-type: none"> • Reduce the quantity of detergent.
Detergent residue in detergent drawer after washing cycle.	<ul style="list-style-type: none"> • Make sure you have used the detergent dispenser according to the indications given in this user manual.
No water is visible in the drum.	<ul style="list-style-type: none"> • Appliances based on modern technology operate very economically using very little water without affecting performance.

After the check, activate the appliance. The programme continues from the point of interruption.

If the problem occurs again, contact the Authorised Service Centre.

The necessary data for the service centre is on the rating plate.

14. CONSUMPTION VALUES

14.1 Introduction



See the web link www.theenergylabel.eu for detailed information about Energy Label.



The QR code on the energy label supplied with the appliance provides a web link to the product information sheet. Keep the energy label for reference together with the user manual and all other documents provided with this appliance.

14.2 Legend

kg	Laundry load.	hh:mm	Programme duration.
kWh	Energy consumption.	°C	Temperature in the laundry.
Litres	Water consumption.	rpm	Spin speed.
%	Remaining moisture at the end of spinning phase. The higher is the spin speed, the higher is the noise and the lower is the remaining moisture.		



Values and programme duration may differ depending on different conditions (e.g. room temperature, water temperature and pressure, load size and type of laundry, supply voltage) and also if you change the default setting of a programme.

14.3 According to UK Ecodesign for Energy-Related Products and Energy Information Regulations

Eco 40-60 programme	kg	kWh	Litres	hh:mm	%	°C	rpm¹⁾
Full load	3	0.497	30.0	2:47	62.00	40.0	1251
Half load	-	-	-	-	-	-	1251
Quarter load	-	-	-	-	-	-	1251

1) Maximum spin speed.

Power consumption in different modes

Off (W)	Stand-by (W)	Delay start (W)
0.10	1.00	4.00

Time to Off/Standby mode is 15 minutes maximum.

14.4 Common programmes



These values are indicative only.

Programme	kg	kWh	Litres	hh:mm	%	°C	rpm ¹⁾
Cottons ²⁾ 90°C	3	1.30	50.0	2:20	53.00	85.0	1300
Cottons 60°C	3	0.89	45.0	2:05	53.00	55.0	1300
Mix ³⁾ 20°C	1,5	0.11	50.0	1:10	50.00	20.0	900
Synthetics 40°C	1,5	0.51	55.0	1:25	35.00	40.0	900
Delicates ⁴⁾ 30°C	1,5	0.33	60.0	1:05	35.00	30.0	700
Wool 30°C	1	0.33	65.0	1:00	30.00	30.0	900

1) Reference indicator of the spin speed.

2) Suitable for washing heavily soiled textiles.

3) Suitable for washing lightly soiled cottons, synthetic and mixed fabrics.

4) It also performs as quick washing cycle for lightly soiled laundry.

15. ENVIRONMENTAL CONCERNS

Recycle materials with the symbol . Put the packaging in relevant containers to recycle it. Help protect the environment and human health by recycling waste of electrical and electronic appliances. Do not dispose of

appliances marked with the symbol  with the household waste. Return the product to your local recycling facility or contact your municipal office.



aeg.com

135958110-A-442023



**UK
CA**