



HDM67G9C2CW/UK

Hotpoint

EN *ENGLISH*

Health and Safety guide

Quick guide

Installation guide

EN

SAFETY INSTRUCTIONS

IMPORTANT TO BE READ AND OBSERVED

⚠ CAUTION : Use of the gas cooking appliance results in the production of heat, moisture and products of combustion in the room in which it is installed. Ensure that the kitchen is well ventilated, especially when the appliance is in use: keep natural ventilation holes open or install a mechanical ventilation device (mechanical extractor hood). Prolonged intensive use of the appliance may call for additional ventilation, such as opening a window, or more effective ventilation, for example increasing the level of mechanical ventilation (if possible).

⚠ Failure to follow the information in this manual exactly may cause a fire or explosion, resulting in property damage or personal injury.

Before using the appliance, read these safety instructions. Keep them nearby for future reference.

These instructions and the appliance itself provide important safety warnings, to be observed at all times. The manufacturer declines any liability for failure to observe these safety instructions, for inappropriate use of the appliance or incorrect setting of controls.

⚠ WARNING: The appliance and its accessible parts become hot during use. Care should be taken to avoid touching heating elements. Children less than 8 years of age must be kept away unless continuously supervised.

⚠ WARNING : Danger of fire : Do not store items on the cooking surfaces.

⚠ CAUTION : The cooking process has to be supervised. A short cooking process has to be supervised continuously.

⚠ WARNING: Leaving the hob unattended when cooking with fat or oil can be dangerous – risk of fire. NEVER try to extinguish a fire with water, but switch off the appliance and then cover the flames e.g. with a lid or a fire blanket.

⚠ Do not use the hob as a work surface or support. Keep clothes or other flammable materials away from the appliance, until all the components have cooled down completely - risk of fire.

⚠ Very young children (0-3 years) should be kept away from the appliance. Young children (3-8 years) should be kept away from the appliance unless continuously supervised. Children from 8 years old and above and persons with reduced physical, sensory or mental capabilities or lack of experience and knowledge can use this appliance only if they are supervised or have been given instructions on safe use and understand the hazards involved. Children must not play with the appliance. Cleaning and user maintenance must not be carried out by children without supervision.

⚠ CAUTION : In case of hotplate glass breakage:- shut immediately off all burners and any electrical heating element and isolate the appliance from the power supply; - do not touch the appliance surface; -do not use the appliance



The glass lid can break if it is heated. Turn off all burners before closing the lid. Do not shut the lid when burners are lit.

⚠ WARNING: The appliance and its accessible parts become hot during use. Care should be taken to avoid touching heating elements. Children less than 8 years of age must be kept away unless continuously supervised.

⚠ Never leave the appliance unattended during use.

⚠ Keep clothes or other flammable materials away from the appliance, until all the components have cooled down completely - risk of fire. Always be vigilant when cooking foods rich in fat, oil or when adding alcoholic beverages - risk of fire. Use oven gloves to remove pans and accessories. At the end of cooking, open the door with caution, allowing hot air or steam to escape gradually before accessing the cavity - risk of burns. Do not obstruct hot air vents at the front of the oven - risk of fire.

⚠ Exercise caution when the oven door is in the open or down position, to avoid hitting the door. When you place the rack inside, make sure that the stop is directed upwards and in the back of the cavity.

The ignition device shall not be operated for more than 15 seconds. If after 15 seconds the burner has not lit, stop operating the device and open the compartment door and/or wait at least 1 min before attempting a further ignition of the burner.

PERMITTED USE

⚠ CAUTION: The appliance is not intended to be operated by means of an external switching device, such as a timer, or separate remote controlled system.

⚠ This appliance is intended to be used in household and similar applications such as: staff kitchen areas in shops, offices and other working environments; farm houses; by clients in hotels, motels, bed & breakfast and other residential environments.

⚠ No other use is permitted (e.g. heating rooms).

⚠ This appliance is not for professional use. Do not use the appliance outdoors.

⚠ Do not store explosive or flammable substances (e.g. gasoline or aerosol cans) inside or near the appliance - risk of fire.

⚠ Use pots and pans with bottoms the same width as that of the burners or slightly larger (see

specific table). Make sure pots on the grates do not protrude beyond the edge of the hob.

⚠ Improper use of the grids can result in damage to the hob: do not position the grids upside down or slide them across the hob.

Do not let the burner flame extend beyond the edge of the pan

Do not use : Cast iron griddles, ollar stones, terracotta pots and pans. Heat diffusers such as metal mesh, or any other types. Two burners simultaneously for one receptacle (e.g. Fish kettle).

Should particular local conditions of the delivered gas make the ignition of burner difficult, it is advisable to repeat the operation with the knob turned to small flame setting.

In case of installation of a hood above the cooktop, please refer to the hood instructions for the correct distance.

The protective rubber feet on the grids represent a choking hazard for young children. After removing the grids, please ensure that all the feet are correctly fitted. (in certain models only)

INSTALLATION

⚠ We recommend the appliance should be handled and installed by two or more persons - risk of injury. Use protective gloves to unpack and install - risk of cuts.

⚠ The electrical and gas connections must comply with local regulation.

⚠ Installation, electrical connections and repairs must be carried out by a qualified technician. Do not repair or replace any part of the appliance unless specifically stated in the user manual. Keep children away from the installation site. After unpacking the appliance, make sure that it has not been damaged during transport. In the event of problems, contact the dealer or your nearest Aftersales Service. Once installed, packaging waste (plastic, styrofoam parts etc.) must be stored out of reach of children - risk of suffocation. The appliance must be disconnected from the power supply before any installation operation - risk of electric shock. During installation, make sure the appliance does not damage the power cable - risk of fire or electric shock. Only activate the appliance when the installation has been completed.

⚠ **WARNING** : Modification of the appliance and its method of installation are essential in order to use the appliance safely and correctly in all the additional countries

⚠ Use pressure regulators suitable for the gas pressure indicated in the instruction.

⚠ The room must be equipped with an air extraction system that expels any combustion fumes.

⚠ Liquid petroleum gas sinks to the floor as it is heavier than air. Therefore, rooms containing LPG cylinders must also be equipped with vents to allow gas to escape in the event of a leak. This means LPG cylinders, whether partially or completely full, must not be installed or stored in rooms or storage areas that are below ground level (cellars, etc.). It is advisable to keep only the cylinder being used in the room, positioned so that it is not subject to heat produced by external sources (ovens, fireplaces, stoves, etc.) which could raise the temperature of the cylinder above 50°C.

Should you find it difficult to turn the knobs for the burner, please contact the After-sales Service, who can replace of the burner tap if found to be faulty.

The openings use for the ventilation and dispersion of heat must never be covered.

GAS CONNECTION

⚠ **WARNING** : Prior to installation, ensure that the local distribution conditions (type of gas and gas pressure) and the configuration of the appliance are compatible.

⚠ Check that the pressure of the gas supply is consistent with the values indicated in Table 1 ("Burner and nozzle specifications").

⚠ **WARNING** : The configuration conditions of this appliance are stated on the label (or data plate).

⚠ **WARNING** : This appliance is not connected to a combustion products evacuation device. It must be installed and connected in accordance with current installation regulations. Particular attention must be paid to the relevant requirements regarding ventilation.

⚠ If the appliance is connected to liquid gas, the regulation screw must be adjusted to the minimum setting.

⚠ **IMPORTANT** : When the gas cylinder or gas container is installed, it must be properly settled (vertical orientation).

⚠ **WARNING** : This operation must be performed by a qualified technician

⚠ The appliance should be connected to the main gas supply or to a gas cylinder in compliance with the current national regulations. Before making the connection, make sure that the appliance is compatible with the gas supply you wish to use. If it is not, follow the instructions indicated in the paragraph "Adapting to different types of gas".

⚠ After connection to the gas supply, check for leaks in accordance with IGEM/UP/1B. Light up the burners and turn the knobs from max position 1* to minimum position 2* to check flame stability.

⚠ Connection to the gas network or the gas cylinder may be carryout using a flexible rubber or steel hose, in accordance with current national legislation.

ADAPTING TO DIFFERENT TYPES OF GAS

(This operation needs to be carried out by a qualified technician.)

⚠ In order to adapt the appliance to a type of gas other than the type for which it was manufactured (indicated on the rating label), follow the dedicated steps provided after installation drawings.

ELECTRICAL WARNINGS

⚠ **IMPORTANT:** Information about current and voltage consumption is provided on the rating plate.

⚠ The rating plate is on the front edge of the oven (visible when the door is open).

⚠ It must be possible to disconnect the appliance from the power supply by unplugging it if plug is accessible, or by a multi-pole switch installed upstream of the socket in accordance with the wiring rules and the appliance must be earthed in conformity with national electrical safety standards.

⚠ The power cable must be long enough to connect the appliance, once fitted in its housing, to the main power supply. Do not pull the power supply cable.

⚠ Do not use extension leads, multiple sockets or adapters. The electrical components must not be accessible to the user after installation. Do not use the appliance when you are wet or barefoot. Do not operate this appliance if it has a damaged power cable or plug, if it is not working properly, or if it has been damaged or dropped.

⚠ If the supply cord is damaged, it must be replaced with an identical one by the manufacturer, its service agent or similarly qualified persons in order to avoid a hazard - risk of electric shock.

⚠ If the power cable needs to be replaced, contact an authorised service centre.

CLEANING AND MAINTENANCE

⚠ **WARNING:** Ensure that the appliance is switched off and disconnected from the power supply before performing any maintenance operation; never use steam cleaning equipment - risk of electric shock.

⚠ Do not use harsh abrasive cleaners or metal scrapers to clean the door glass since they can scratch the surface, which may result in shattering of the glass.

⚠ Do not use abrasive or corrosive products, chlorine-based cleaners or pan scourers.

⚠ Make sure the appliance has cooled down before cleaning or performing maintenance. - risk of burns.

⚠ **WARNING:** Switch off the appliance before replacing the lamp - risk of electric shock.

⚠ To avoid damaging the electric ignition device, do not use it when the burners are not in their housing.

Wear protective gloves for cleaning and maintenance.

DISPOSAL OF PACKAGING MATERIALS

The packaging material is 100% recyclable and is marked with the recycle symbol . The various parts of the packaging must therefore be disposed of responsibly and in full compliance with local authority regulations governing waste disposal.

DISPOSAL OF HOUSEHOLD APPLIANCES

This appliance is manufactured with recyclable or reusable materials. Dispose of it in accordance with local waste disposal regulations. For further information on the treatment, recovery and recycling of household electrical appliances, contact your local authority, the collection service for household waste or the store where you purchased the appliance. This appliance is marked in compliance with European Directive 2012/19/EU, Waste Electrical and Electronic Equipment (WEEE) and with the Waste Electrical and Electronic Equipment regulations 2013 (as amended).

By ensuring this product is disposed of correctly, you will help prevent negative consequences for the environment and human health. The symbol  on the product or on the accompanying documentation indicates that it should not be treated as domestic waste but must be taken to an appropriate collection centre for the recycling of electrical and electronic equipment.

ENERGY SAVING TIPS

Only preheat the oven if specified in the cooking table or your recipe. Use dark lacquered or enamelled baking trays as they absorb heat better.

Use a pressure cooker to save even more energy and time.

DECLARATIONS OF CONFORMITY

This appliance meets Ecodesign requirements of European Regulation 66/2014 and The Ecodesign for Energy-Related Products and Energy Information (Amendment) (EU Exit) Regulations 2019 in compliance with the European standard EN 30-2-1.

This appliance meets: Ecodesign requirements of European Regulation 66/2014; Energy Labelling Regulation 65/2014; Ecodesign for Energy-Related Products and Energy Information (Amendment) (EU Exit) Regulations 2019, in compliance with the European standard EN 60350-1.

PRODUCT DESCRIPTION

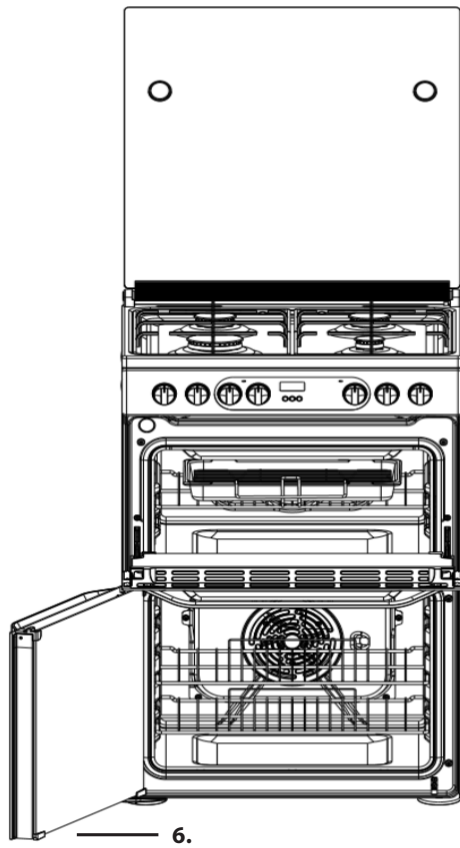

- 1. Glass cover
- 2. Gas burners
- 3. Control panel
- 4. Runners for accessories
(the level is indicated on the wall of the cooking compartment)
- 5. Removable Inner Door Glass
- 6. Main oven door

CONTROL PANEL

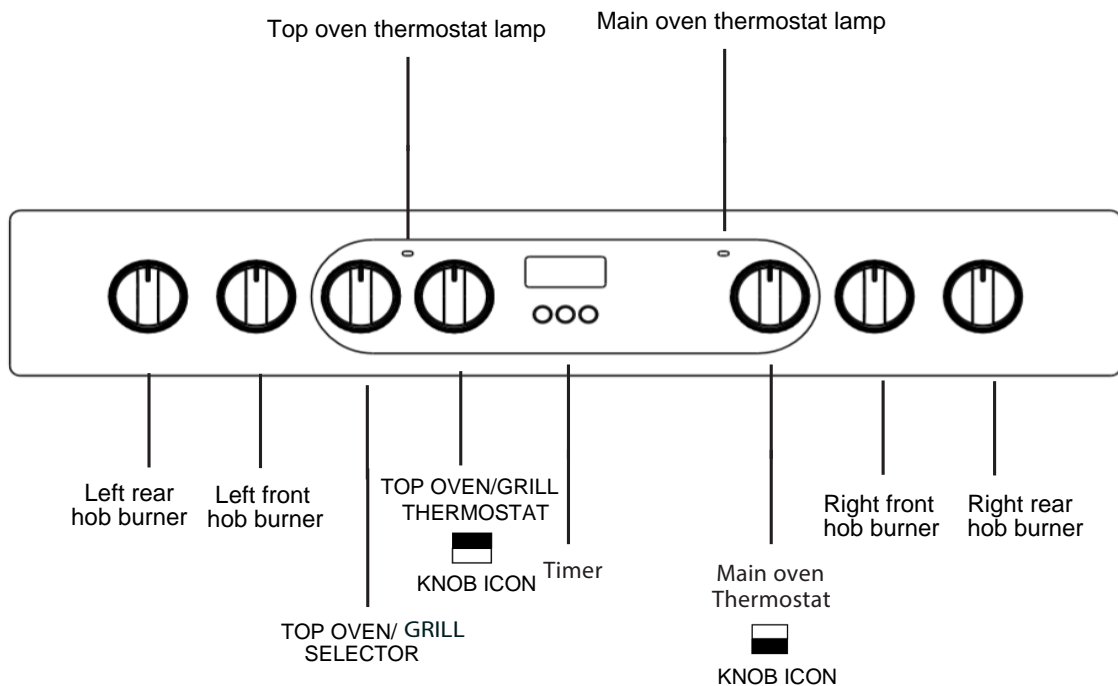

INSTALLATION TIPS

⚠ WARNING : This operation must be performed by a qualified technician

Before moving your cooker check that it is cool, and switch off at the cooker control unit. Movement of your cooker is most easily achieved by lifting the front as follows:

Open the grill door sufficiently to allow a comfortable grip on the underside front edge of the oven roof, avoiding any grill elements. (FIG.A)

Take care in moving the cooker as it is heavy. Take care to ensure that any floor covering is not damaged.

The following instructions should be read by a qualified technician to ensure that the appliance is installed, regulated and technically serviced correctly in compliance with current regulations.

Positioning

This unit may be installed and used only in permanently ventilated rooms according to the British Standards Codes Of Practice: BS 5440 Part 2

The following requirements must be observed:

- The cooker should not be installed in a bed sitting room with a volume of less than 20m³. If it is installed in a room of volume less than 5m³ an air vent of effective area of 100cm² is required, if it is installed in a room of volume between 5m³ and 10m³ a supplementary airvent area of 50cm² is required, if the volume exceeds 10m³ no airvent is required. However, if the room has a door or a window which opens directly to the outside no air vent is required even when the volume is between 5m³ and 10m³. The room containing the appliance must contain an openable window or an acceptable alternative such as an adjustable louvre or hinged panel opening direct to outside air.
- During prolonged use of the appliance you may consider it necessary to open a window to the outside to improve ventilation.
- If there are other fuel burning appliances in the same room, B.S.5440 Part 2 Current Edition, should be consulted to determine the requisite air vent.

Installation of the cooker

For a correct installation of the cooker the following precautions must be followed:

The height of the cooker can be adjusted by means of adjustable feet in the base of the product (900mm - 915mm). To allow alignment with a worktop of greater than 915mm (max 940mm), longer adjustable feet are available as a spare part on request.

Adjust the feet by tilting the cooker from the side. Then install the product into position.

NOTE: This appliance must not be fitted on a platform.

The cooker is designed to fit between kitchen cabinets spaced 600mm apart. The space either side need only be sufficient to allow withdrawal of the cooker for servicing. It can be used with cabinets one side or both as well as in a corner setting. It can also be used free-standing. Adjacent side walls which project above hob level, must not be nearer to the cooker than 65mm and should be protected by heat resistant material. Any overhanging surface or cooker hood should not be nearer than 750mm.

- The cooker may be located in a kitchen, a kitchen/diner or bed sitting room, but not in a bathroom or shower room.
- The hoods must be installed according to the requirements in the hood handbook (minimum 750mm)
- The wall behind the cooker, 50mm below and 450mm above, and the width of the cooker, must be a noncombustible material such as ceramic wall tiles.
- The cooker should be secured to the wall behind via a safety chain and hook. (fig.B)

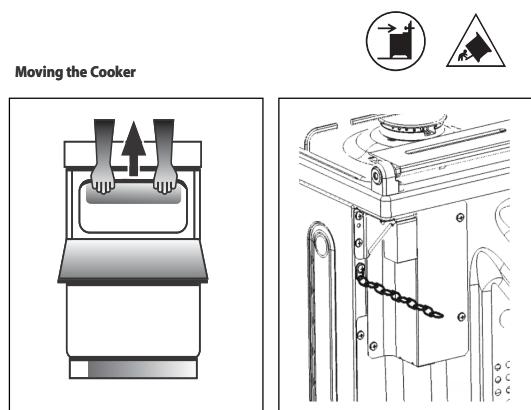

Fig. A

Fig. B

⚠ WARNING : This operation must be performed by a qualified technician

Gas connection

The cooker should be connected to the gas-supply by a gas safe registered installer. Connection of the appliance to the gas mains or liquid gas must be carried out according to the prescribed regulation in force, and only after it is ascertained that it is adaptable to the type of gas to be used. If not, follow the instructions indicated in the paragraph headed "Adaptation to different gas types". In the case of connection to liquid gas, by tank, use pressure regulators that conform to the regulation in force. The gas supply must be connected to the left of the appliance. Be sure that the hose does not pass through the rear of the cooker touching hot parts.

Make sure the supply pressure conforms with the values shown in the table entitled "Characteristics of the burners and nozzles".

When the cooker is installed between cabinets (recessed), the gas connection must be effected by an approved flexible hose with bayonet fitting (BS 669 or EN 14800). The gas inlet for the cookers is a threaded G 1/2 gas female fitting.

Connecting the gas supply

To make the connection, a flexible hose should be used corresponding to the current gas regulations which are:

- the hose must never be at any point in its length in contact with the "hot" parts of the cooker;
- the hose must never be longer than 1,5 metre;
- the hose must not be subject to any tension or torsional stress and it must not have any excessively narrow curves or bottlenecks;
- the hose must be easy to inspect along its entire length to check its condition;
- the hose must always be in good condition, never attempt to repair.

Adapting the cooker to different types of gas

In order to adapt the cooker to a different type of gas with respect to the gas for which it was produced follow these steps:

- replace the hose holder mounted on the appliance with that supplied in the bag of "cooker accessories".
- Replacing the burner nozzles on the hob:

- remove the grids and slide the burners from their housings;
- unscrew the nozzles using a 7 mm socket spanner, and replace them with nozzles for the new type of gas (see table 1 "Burner and nozzle characteristics").
- replace all the components by repeating the steps in reverse order.

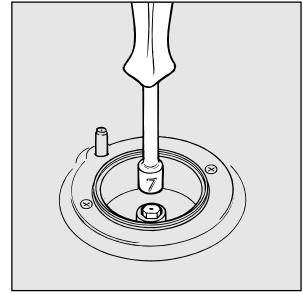

c) Minimum regulation of the hob burners:

- turn the tap to minimum;
- remove the knob and adjust the regulation screw, which is positioned in or next to the tap pin, until the flame is small but steady.

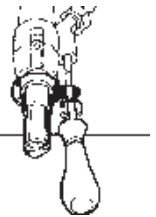

In the case of liquid gas, the regulation screw must be adjusted to the minimum setting.

- check that the flame does not turn off when you turn the tap quickly from high to low.

d) Regulating the primary air of the burners:

The primary air of the burners requires no regulation.

On completion of the operation, replace the old rating sticker with one indicating the new type of gas used.

ELECTRICAL CONNECTION

⚠ WARNING : This operation must be performed by a qualified technician

WARNING - THIS APPLIANCE MUST BE EARTHED.

The cooker must be connected by a qualified electrician to a suitable double - pole control unit with a minimum rating of 32A and a minimum contact clearance of 3mm, which should be fitted adjacent to (but not above) the cooker, in accordance with IEE regulations. The power supply cable should conform to BS6004 with a conductor size of 4mm².

The control unit should be easily accessible in the event of an emergency. This appliance conforms to EN55014 regarding suppression of radio and television interference. The cooker terminals are behind the cover at the rear. The mains cable must pass through the cable clamp and the screws must be fully tightened. Sufficient cable should be used to allow the cooker to be pulled out for servicing. Ensure that the cover is fully closed and secure afterwards. Take care not to trap the mains cable when pushing the cooker into its final position.

**FIRST TIME USE
DAILY USE**

HOTPLATE

The hotplate lid is fitted with a safety device which cuts off the gas supply to the hotplate burners unless the lid is fully open. Do not use the safety device as a means of controlling the hotplate burners.

The hotplate has two high speed burners and two simmering burners which will accommodate pans between 100mm (4") and 240mm (9 1/2") diameter. All pans should be positioned centrally over the burners.

TO USE THE HOTPLATE

1. Remove any items or spillage from the top of the lid and then raise it to its fully open position.
2. Push in and turn the control knob of the chosen burner anti-clockwise to the large flame symbol. Continue to press the ignition button until the sparks light the gas.

For the models with the electronic ignition button (★), press the button and then turn the knob.

3. Turn the control knob anti-clockwise to reduce the heat input. Only turn the control knob between the large flame symbol and the small flame symbol when adjusting the setting.
4. To turn off, turn the control knob fully clockwise to the symbol ○.

Each burner is fitted with a spark ignitor for lighting the gas. To ensure rapid lighting of the burners every time they are used, the ignitors must be kept **clean and dry**.

Remove any food spillage or cleaning materials from the ignitor using a small nylon brush such as a tooth brush. Access to the ignitor can be achieved by lifting off the loose burner parts carefully when the burners are cool.

When the hotplate burner bodies and caps are removed for cleaning, be careful not to drop any food particles or cleaning materials into the burner bases, to avoid the possibility of blocking the gas jets.

If aluminium based pans are used, a silvery deposit may appear on the top edge of the pan support fingers. See 'Cleaning and Maintenance' section for cleaning information.

Models with Hob Gas Burner Safety Devices to Prevent Leaks

These models can be identified by the presence of the device itself. **!** Since the hob burners are equipped with a safety device, you must hold the

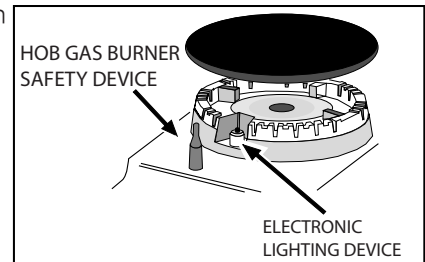

control knob in for about 3-7 seconds after the burner has been lighted to allow the gas to pass until the safety thermocouple has heated.

LEVEL	COOKING TIPS
1 - 2 - 3	Ideal for softening butter, gently melting chocolate in bagnemarie, thawing small portions, creaming risotto, keeping warm small portions of just-cooked preparation
4 - 5	Ideal for slow-cook recipes (rice, sauces, roast, fish) using liquids (water, wine, broth), and for creaming pasta, maintaining a gentle boiling
6 - 7	Ideal for sautéing, stewing vegetables, cooking for longer period, preheating accessories, cooking until creamy
8 - 9	Ideal for browning, starting to cook, bringing liquids to the boil quickly, frying deep-frozen products, grilling meat and fish, maintaining a lively boil
10	Ideal for rapidly increasing the temperature of food or for heating up liquids (water)

MAIN OVEN

To heat the oven turn the knob clockwise, selecting the required temperature between 80°C (176°F) and 250°C (482°F) as recommended in the temperature chart. The pilot light will immediately come on and remain on until the oven reaches the required temperature. This light will then automatically go off and on during cooking as the oven thermostat maintains the correct temperature.

It should be noted that at the end of the cooking period there may be a momentary puff of steam when the oven door is opened. This will disperse in a few seconds and is a perfectly normal characteristic of an oven with a good door seal.

Since a circulaire fan oven heats up more quickly, and generally cooks food at a lower temperature than a conventional oven, pre-heating is often unnecessary. However, foods such as bread, scones, Yorkshire pudding, do benefit from being placed in a pre-heated oven.

The 'oven temperature charts' are a guide only, giving approximate cooking temperatures and times. To suit personal taste and requirements, it may be necessary to increase or decrease temperatures by 10°C.

Unless otherwise indicated in the charts food should be placed in a cold oven, i.e. without pre-heating. If food is placed in an already hot oven, the suggested cooking time should be reduced, depending on the type and quantity of food being cooked.

Oven positions

Since the distribution of heat in the circulaire fan oven is very even, most foods will cook satisfactorily on any shelf position, but the shelves should be evenly spaced.

The top oven rod shelf can be used in the main oven when cooking large quantities of food.

Food or utensils should Never be placed directly on the floor of the oven for cooking.

Never use more than 4 shelves in the oven as air circulation will be seriously restricted. To ensure oven circulation do not use meat pans larger than 390 x 300mm (15"x12") and baking trays no larger than 330 x 255mm (13"x 10"), these should be positioned centrally on the oven shelf.

Food should not be placed directly on the floor of the oven. To avoid unnecessary cleaning, rod shelves which are not in use, should be removed from the oven.

Temperature and time

When all four shelves are used to cook large quantities of food for home freezing or parties, it may be necessary to increase the cooking times given in the temperature charts by a few minutes, to allow for the loss of heat due to extra time taken to load the oven, and the larger mass of food. Baking trays should have an equal gap at either side of the oven.

TOP OVEN

The top oven should be used to cook small quantities of food. The oven is designed so that the grill element operates at a reduced heat output, this is combined with a heating element situated underneath the floor of the oven.

To ensure even cooking of the food it is important that cooking utensils are positioned correctly on the oven shelf so that the element is directly above.

There are two cooking positions, the shelf placed on runner 1 or 2 (from the base), do not use shelves upside down.

Food/utensils must not be placed directly on the oven floor.

There should always be at least 25mm (1in) between the top of the food and the grill element.

Warning: Items stored in top oven will get hot when main oven is in use.

Operation

While the top oven is heating up, the pilot light will come on and remain on until the oven reaches the required temperature. The pilot light will automatically go on and off during cooking as the thermostat maintains the correct temperature.

Do not use the grill pan as a meat pan in the top oven as air circulation will be seriously restricted.

Top oven as a warming compartment for plates

Place the plates/dishes on the shelf, positioned on runner 1, turn top oven control to 100°C for 10-15 minutes. Never use grill control.

When the cooker is first used an odour may be emitted, this will cease after a period of use.

When first using the cooker ensure that the room is well ventilated (e.g. open a window or use an extractor fan) and that persons who may be sensitive to the odour avoid any fumes. It is suggested that any pets be removed from the room until the smell has ceased. This odour is due to temporary finish on oven liners and elements and also any moisture absorbed by the insulation.

GAS NOZZLE TABLE

Mains frequency and voltage of the electric section and characteristics of the gas section

Model	Gas section	
	Gas category	Rated power kW (1)
HDM67G9C2CW/UK	I12H3+	8,00 (582 g/h-G30) (571 g/h-G31)

(1) The values in g/h refer to the capacities with liquid gas (Butane, Propane).

Table 1

Burner	Diameter (mm)	Liquid Gas						Natural Gas			
		Thermal Power kW (p.c.s.*)		By-Pass 1/100 (mm)	Nozzle 1/100 (mm)	Flow* g/h		Thermal Power kW (p.c.s.*)		Nozzle 1/100 (mm)	Flow* l/h
		Nominal	Reduced			***	**	Nominal	Reduced		
Fast (Large) (R)	100	3.0	0.7	41	86	218	214	3.0	0.7	116	286
Semi Fast (Medium) (S)	75	2.0	0.4	30	70	145	143	2.0	0.4	103	190
Auxiliary (Small) (A)	55	1.0	0.4	30	50	73	71	1.0	0.4	79	95
Supply Pressures	Nominal (mbar) Minimum (mbar) Maximum (mbar)					28-30 20 35	37 25 45				20 17 25

* At 15°C and 1013 mbar - dry gas

*** Butane P.C.S. = 49,47 MJ/Kg

** Propane P.C.S. = 50,37 MJ/Kg

Natural P. C.S. = 37,78 MJ/m³

The front right hob burner injector should be used as the pressure test point.

ACCESSORIES

GRID

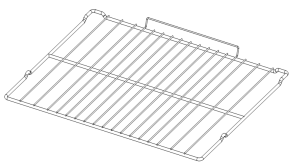

KIT GRILL PAN

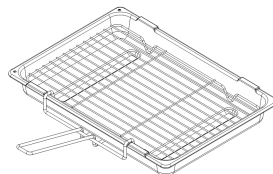

The grill pan handle is detachable from the pan to facilitate cleaning and storage. Fix the pan handle securely before use:

1. Fit the handle to the grill pan so that the external 'hooks' embrace the edge of the pan (fig. 1)
2. Make sure that the middle part of the handle fits exactly the protruding support of the pan (fig. 2) and holds the pan from the bottom.

The food must be placed on the rack in the grill pan. Position the grill pan on top of the oven rack. The best results are achieved following the cooking table. Pouring a little water into the grill pan will make the collection of grease particles more efficient and prevent the formation of smoke.

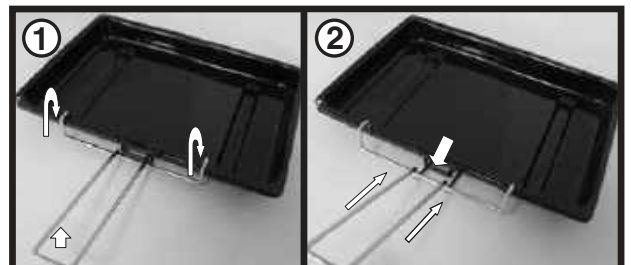

The number and type of accessories may vary depending on which model is purchased. Other accessories that are not supplied can be purchased separately from the After-sales Service.

1. SELECT A FUNCTION

To select a function, turn the Top Oven/Grill Selection Knob to the symbol for the function you require, then select the required temperature by turning the Top Oven/Grill Temperature Knob.

TOP OVEN

MAIN OVEN - FAN COOKING

This control switches on the main oven. Fan Cooking - Turn the control clockwise and select any temperature between 80°C and Max. As the control is turned the fan will start. The main oven light will immediately come on. The thermostat light indicates that the main oven is heating. When it turns off, the temperature inside the oven has reached the setting made with the main oven knob. At this point, the light will turn on and off as the oven maintains the temperature at a constant level. The fan and the oven interior light will remain on throughout cooking. The heat for fan cooking in the main oven is provided by an element situated at the back of the oven, around the fan. Fan cooking is ideal for large poultry or joints of meat, reducing cooking times and often eliminating the need for pre-heating the oven. It is also ideal for batch cooking where food is cooked on more than one level, because the forced circulation of hot air gives an even temperature from the top to the bottom of the oven.

**FORCED AIR**

For cooking different foods on multiple shelves (maximum of four) at the same time. This function can be used to cook different foods without odours being transferred from one food to another.

**CONVENTIONAL**

For cooking any kind of dish on one shelf only.

**BOTTOM**

This function can be used to finish cooking filled pies or to thicken soups. Use this function the last 10/15 minutes of cooking.

**HALF GRILL**

For grilling small food like bacon or toasting bread. The grill pan is placed on top of the top oven cavity shelf. The shelf position can be adjusted to allow for grilling different types of food.

**GRILL**

For grilling steaks, kebabs and sausages, cooking vegetables au gratin or toasting bread. When grilling meat, we recommend using a drip tray to collect the cooking juices: Position the pan on one of the levels below the wire shelf and add 200 ml of drinking water.

CLOCK/MINUTE MINDER OPERATION

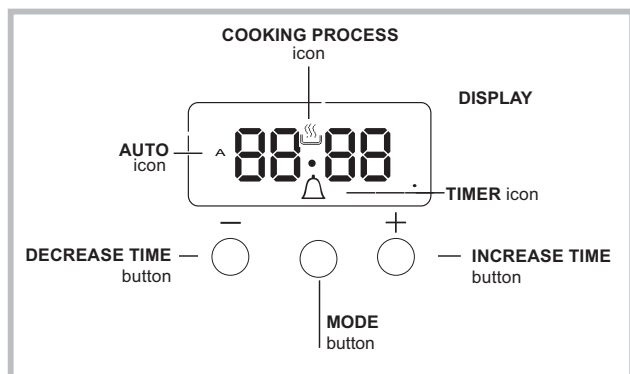

Setting the clock

The clock may be set when the oven is switched off or when it is switched on, provided that the end time of a cooking cycle has not been programmed previously. After the appliance has been connected to the mains, or after a blackout, the 00:00 digits on the DISPLAY will begin to flash.

1. Press the "+" and "-" button simultaneously. Then the colon between hours and minutes is flashing.
2. Use the "+" and "-" buttons to adjust the time; if you press and hold either button, the display will scroll through the values more quickly, making it quicker and easier to set the desired value.

Changing the buzzer frequency

The buzzer signal frequency can be changed by touching the "-" repeatedly.

Setting the minute minder

This function does not interrupt cooking and does not affect the oven; it is simply used to activate the buzzer when the set amount of time has elapsed.

1. Press the MODE button several times until the bell icon and the three digits on the display begin to flash.
2. Use the "+" and "-" buttons to set the desired time; if you press and hold either button, the display will scroll through the values more quickly, making it quicker and easier to set the value.
3. Wait for 5 seconds, if you press the button one more time the display will then show the time as it counts down. When this period of time has elapsed the buzzer will be activated.

Programming cooking

A cooking mode must be selected before programming can take place.

Programming the cooking duration

1. Press the MODE button several times until icon A and the DUR digits on the DISPLAY begin to flash.
2. Use the "+" and "-" buttons to set the desired duration; if you press and hold either button, the display will scroll through the values more quickly, making it quicker and easier to set the value.
3. Wait for 5 seconds, after that the icon A will be visible on the display.
4. When the set time has elapsed and the oven will stop cooking you will hear a buzzer sounds. Press any button to stop the buzzer.
 - For example: it is 9:00 a.m. and a time of 1 hour and 15 minutes is programmed. The programme will stop automatically at 10:15 a.m.

Setting the end time for a cooking mode

1. Follow steps 1 to 3 to set the duration as detailed above.
2. Next, press the MODE button until the text END on the display begin to flash.
3. use the "+" and "-" buttons to adjust the cooking end time; if you press and hold either button, the display will scroll through the values more quickly, making it quicker and easier to set the desired value.
4. Wait for 5 seconds or press the MODE button again, When the cooking process start, the symbol is visible on the display.
5. When the set time has elapsed, the oven will stop cooking and a buzzer sounds. Press any button to stop it. Programming has been set when the icon A is illuminated.
 - For example: It is 9:00 a.m. and a duration of 1 hour has been programmed. 12:30 is scheduled as the end time. The programme will start automatically at 11:30 a.m.

























Cancelling a programme

To cancel a programme:









- press the MODE button until the icon corresponding to the setting you wish to cancel and the digits on the display are flashing. Press the "-" button until the digits 00:00 appear on the display.
- Press and hold the "+" and "-" buttons; this will cancel all the settings selected previously, including timer settings.

COOKING TABLE

MAIN OVEN



























RECIPE	FUNCTION	PREHEAT	TEMPERATURE (°C)	DURATION (Min)	LEVEL (L-number) AND ACCESSORIES
Leavened cakes / Sponge cakes	FORCED AIR	YES	160-170	30-50	2 
Leavened cakes / Sponge cakes	FORCED AIR	YES	160-170	30-50	2/4 
Filled cake (cheese cake, strudel, fruit pie)	FORCED AIR	YES	160-180	50-70	2 
Filled cake (cheese cake, strudel, fruit pie)	FORCED AIR	YES	150-170	40-70	2/4 
Cookies / Shortbread	FORCED AIR	YES	140-150	40-50	3 
Cookies / Shortbread	FORCED AIR	YES	140-150	40-60	2/4 
Cookies / Shortbread	FORCED AIR	YES	140-150	35-50	2/4/5 
Small cakes / Muffin	FORCED AIR	YES	160-170	30-50	3 
Small cakes / Muffin	FORCED AIR	YES	150-160	30-50	2/5 
Small cakes / Muffin	FORCED AIR	YES	150-160	40-60	1/3/5 
Choux buns	FORCED AIR	YES	170-200	30-60	3 
Choux buns	FORCED AIR	YES	170-200	20-50	4  2 
Choux buns	FORCED AIR	YES	170-200	20-50	1/3/5 
Pizza / Bread / Focaccia	FORCED AIR	YES	190-250	15-50	2 
Pizza / Bread / Focaccia	FORCED AIR	YES	190-230	20-50	2/4 
Pizza / Bread / Focaccia	FORCED AIR	YES	190-230	20-50	2/4/5 
Savoury pies (vegetable pie, quiche)	FORCED AIR	YES	180	30-60	3 
Vols-au-vent / Puff pastry crackers	FORCED AIR	YES	180-210	15-40	3 
Vols-au-vent / Puff pastry crackers	FORCED AIR	YES	180-210	15-40	4  2 
Lasagne / Flans / Baked pasta / Cannelloni	FORCED AIR	YES	180-200	40-75	3 
Lamb / Veal / Beef / Pork 1 kg	FORCED AIR	YES	190-200	80-110	3 
Chicken / Rabbit / Duck 1 kg	FORCED AIR	YES	200-230	50-100	3 





COOKING TABLE

Fish fillets / Steaks	FORCED AIR	YES	180-200	20-30	3 
Roast potatoes	FORCED AIR	YES	190-220	40-80	3 
Vegetable gratin	FORCED AIR	YES	180-200	20-30	3 
Stuffed vegetables (tomatoes, courgettes, aubergines)	FORCED AIR	YES	190-220	40-80	3 
Complete meal: (Cook3) Fruit tart Lasagna Roast	FORCED AIR	-	180-190	40-100	1  3/5 
Complete meal (Cook4) Fruit tart Lasagna Cuts of meat Roasted vegetables	FORCED AIR	-	180-190	40-80	1/2  3/5 

COOKING TABLE

TOP OVEN

RECIPE	FUNCTION	PREHEAT	TEMPERATURE (°C)	DURATION (MIN)	LEVEL (L –number and accessories)
Leavened cakes / Sponge cakes	CONVENTIONAL	YES	170	20-50	1  
Filled cake (cheese cake, strudel, fruit pie)	CONVENTIONAL	YES	160-180	40-60	2 
Cookies / Shortbread	CONVENTIONAL	YES	140-150	20-50	2 
Small cakes / Muffin	CONVENTIONAL	YES	160-170	20-50	2 
Choux buns	CONVENTIONAL	YES	170-200	20-50	2 
Meringues	CONVENTIONAL	YES	80-100	120-200	2 
Pizza / Bread / Focaccia	CONVENTIONAL	YES	190-250	15-50	2 
Vols-au-vent / Puff pastry crackers	CONVENTIONAL	YES	180-210	15-40	2 
Lasagne / Flans / Baked pasta / Cannelloni	CONVENTIONAL	YES	180-200	30-65	2  
Lamb / Veal / Beef / Pork 1 kg	CONVENTIONAL	YES	190-200	20-50	2  
Chicken / Rabbit / Duck 1 kg	CONVENTIONAL	YES	200-230	50-100	2  
Fish fillets / Steaks	GRILL	-	230 - MAX	15 - 35	2 
Stuffed vegetables (tomatoes, courgettes, aubergines)	CONVENTIONAL	YES	190-220	40 - 80	2  
Vegetable gratin	GRILL	-	230-MAX	10-30	2  
Toast	GRILL	5'	MAX	0.5-1.5	2 
Sausages / Kebabs / Spare ribs / Hamburgers	GRILL	-	230 - MAX	15-30	2 
Roast potatoes	CONVENTIONAL	YES	190-220	40-80	2  
Leg of lamb/Shanks	CONVENTIONAL	YES	200-230	50-100	2  

ACCESSORIES					
	Wire shelf	Baking dish or cake tin on the wire shelf	Baking tray/Drip tray or Baking dish on the wire shelf	Drip tray / Baking tray	Drip tray / Baking tray with 500 ml of water

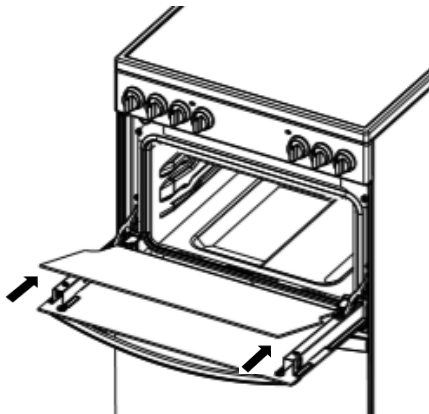
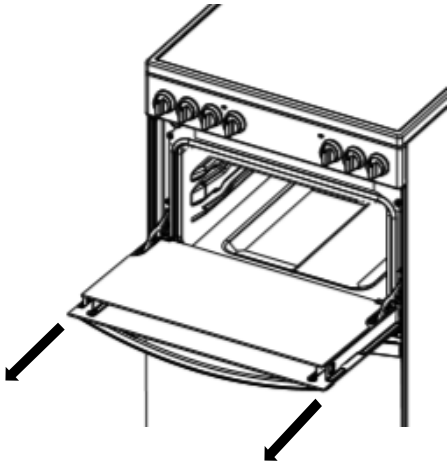
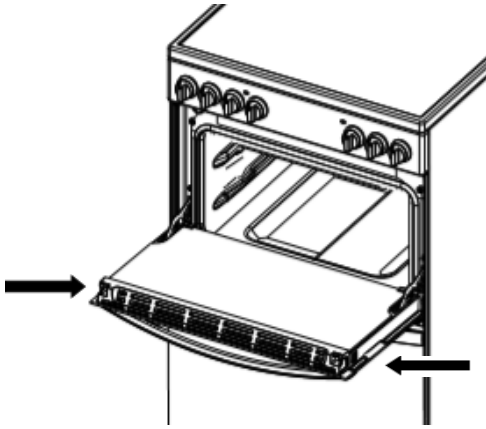

Cleaning the glass door with 2 panels

TOP OVEN DOORS

1.

Open the door to 30°. Removing the retaining bar depress carefully the clips on both sides of the bar. Pull the trim up gently until the retainer is released.

2.

Carefully slide the first inner glass towards you, taking care not to allow the glass to fall.

3.

Now the external glass panel can be washed.

Ensure the glass panel is not subjected to any sharp mechanical blows. Take particular care not to damage the inner surface which is coated with a heat reflective layer. After cleaning, rinse and dry with a soft cloth. For slight soiling the inner glass panel may be cleaned, while still warm, without removing it from the door.

Oven must not be operated with inner door glass removed.

4.

To reassemble the oven doors proceed with inserting the glass panels in the reverse order, pushing gently every panel directly into the liners, so that the warning sign printed on the glass is correctly legible.

CLEANING AND MAINTENANCE

TURN OFF THE MAIN SWITCH AND ENSURE THE COOKER IS COLD BEFORE CLEANING. BEFORE SWITCHING ON AGAIN, ENSURE THAT ALL CONTROLS ARE IN THE OFF POSITION.

Do not use steam cleaning equipment.

Use protective gloves during all operations.

Carry out the required operations when the oven is cold.

Disconnect the appliance from the power supply.

Do not use wire wool, abrasive scourers or abrasive/corrosive cleaning agents, as these could damage the surfaces of the appliance.

Disconnect the appliance from the power supply

CLEANING THE HOB SURFACE

All the enamelled and glass parts should be cleaned with warm water and neutral solution. Stainless steel surfaces may be stained by calcareous water or aggressive detergents if left in contact for too long. Any food spills (water, sauce, coffee, etc.) should be wiped away before they dry.

Clean with warm water and neutral detergent, and then dry with a soft cloth or chamois. Remove baked-on dirt with specific cleaners for stainless steel surfaces.

NOTE: clean stainless steel only with soft cloth or sponge.

Do not use abrasive or corrosive products, chlorine-based cleaners or pan scourers.

Do not use steam cleaning appliances.

Do not use flammable products.

Do not leave acid or alkaline substances, such as vinegar, mustard, salt, sugar or lemon juice on the hob.

CLEANING THE HOB PARTS

Clean glass and enamelled parts only with soft cloth or sponge. Grids, burner caps and burners can be removed to be cleaned. Clean them by hand with warm water and non-abrasive detergent removing any food residues and checking that none of the burner openings is clogged.

Rinse and dry.

Refit burners and burner caps correctly in the respective housings.

When replacing the grids, make sure that the panstand area is aligned with the burner.

Models equipped with electrical ignition plugs and safety device require thorough cleaning of the plug end in order to ensure correct operation. Check these items frequently, and if necessary, clean them with a damp cloth. Any baked-on food should be removed with a toothpick or needle.

NOTE: to avoid damaging the electric ignition device, do not use it when the burners are not in their housing.

CLEANING THE OVEN SURFACE

EXTERIOR SURFACES

- Clean the surfaces with a damp microfibre cloth. If they are very dirty, add a few drops of pH-neutral detergent. Dry them with a dry cloth.
- Do not use corrosive or abrasive detergents. If any of these products inadvertently comes into contact with the surfaces of the appliance, clean immediately with a damp microfibre cloth.

INTERIOR SURFACES

- After every use, leave the oven to cool and then clean it, preferably while it is still warm, to remove any deposits or stains caused by food residues. To dry any condensation that has formed as a result of cooking foods with a high water content, let the oven to cool completely and then wipe it with a cloth or sponge.
- Clean the glass in the door with a suitable liquid detergent.

ACCESSORIES

Soak the accessories in a washing-up liquid solution after use, handling them with oven gloves if they are still hot. Food residues can be removed using a washing-up brush or a sponge.

REPLACING THE LIGHT

1. Disconnect the oven from the power supply.
2. Unscrew the cover from the light, replace the bulb and screw the cover back on the light.

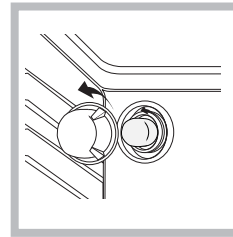

3. Reconnect the oven to the power supply.
Note: Use 40 W/230 V type G9

The bulb used in the product is specifically designed for domestic appliances and is not suitable for general room lighting within the home (EC Regulation 244/2009). Light bulbs are available from our After-sales Service.

- Do not handle bulbs with your bare hands as your fingerprints could damage them. Do not use the oven until the light cover has been refitted.

This product contains a light source of energy efficiency class G

CATALYTIC CLEANING

These are panels coated with a special enamel, which is able to absorb the fat released by food as it cooks. This enamel is quite strong, so that the various accessories (racks, dripping pans, etc.) can slide along them without damaging them. White marks may appear on the surfaces; these are not a cause for concern. Nevertheless, the following should be avoided:

- scraping the enamel with sharp objects (a knife, for example);
- using detergents or abrasive materials.

LOWER THE TOP HEATING ELEMENT (Only in some models)

The top heating element of the grill can be lowered to clean the upper panel of the oven: Extract the heating element from its seating, then lower it. To return the heating element to its position, lift it up, pull it slightly towards you and make sure that the tab support is in its proper seating.

HOW TO READ THE COOKING TABLE

The table indicates the best function to use with certain types of food cooked on a single shelf. Cooking times start from the moment food is placed in the oven, excluding pre-heating (where required). Cooking temperatures and times are purely for guidance and will depend on the amount of food and type of accessory used. Use the lowest recommended settings to begin with and, if the food is not cooked enough, then switch to higher settings. Use the accessories supplied and preferably dark-coloured metal cake tins and baking trays. You can also use Pyrex pans and accessories or ones made from china, but bear in mind that cooking times will be slightly longer. For best results, follow the recommendations in the cooking table carefully when selecting which of the supplied accessories to place on which of the shelves.

TROUBLESHOOTING

Problem	Possible cause	Solution
The oven or the burner will not switch on.	Power cut. Disconnection from the mains electricity.	Check for the presence of mains electrical power and whether the oven is connected to the electricity supply. Wait at least one minute, then try to switch the oven on again and see if the problem persists.
	Gas supply interrupted.	Check that the gas tap upstream of the oven is open or that the liquid gas cylinder (if being used) is not empty.
	Switch-on procedure carried out incorrectly.	Wait at least one minute and then repeat the steps described in the "Daily use" section.

In the event of problems, turn the adjustment knob back to the 0 position and open the oven door.

AFTER-SALES SERVICE

To receive assistance, call the number given on the warranty leaflet enclosed with the product or follow the instructions on our website. Be prepared to provide:

- a brief description of the problem;
- the exact model type of your product;
- the assistance code (the number following the word SERVICE on the identification plate attached to the product, which can be seen on the inside edge when the oven door is open);
- your full address;
- a contact telephone number.

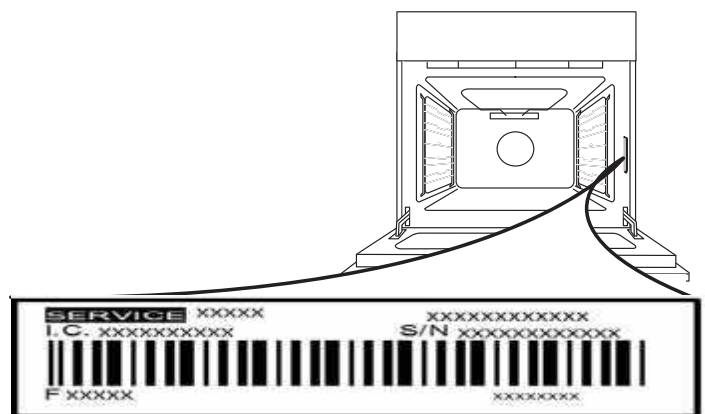

Please note: If repairs are required, contact an authorised service centre that is guaranteed to use original spare parts and perform repairs correctly.

Please refer to the enclosed warranty leaflet for more information on the warranty.

 A complete product specification, including the energy efficiency ratings for this oven, can be read and downloaded from our website www.hotpoint.co.uk

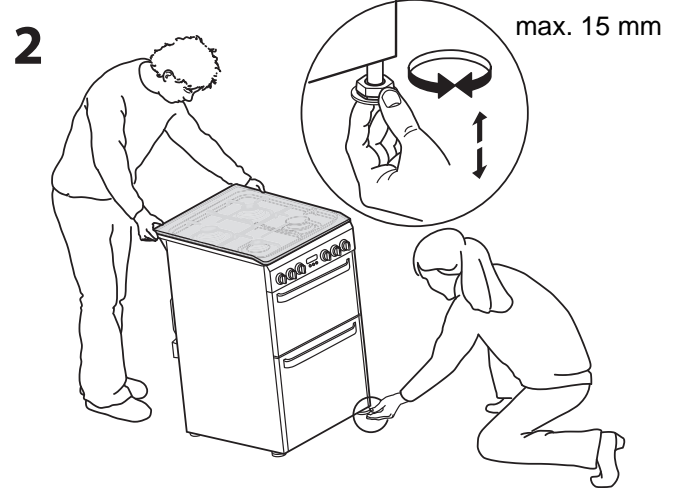
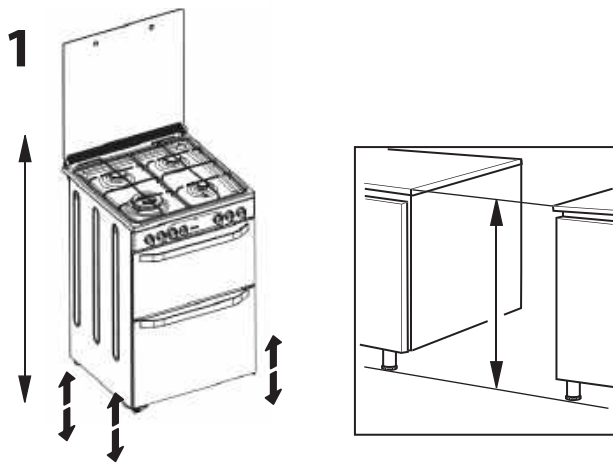
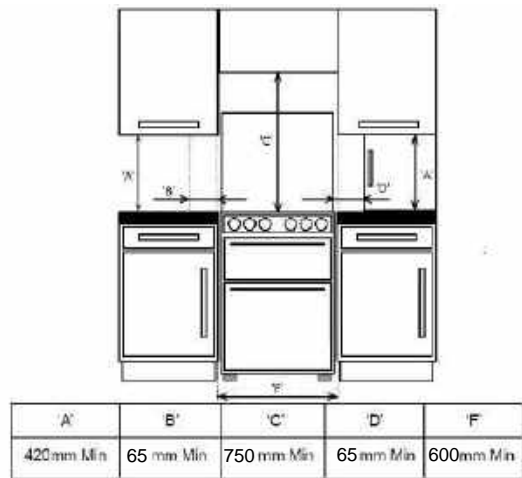
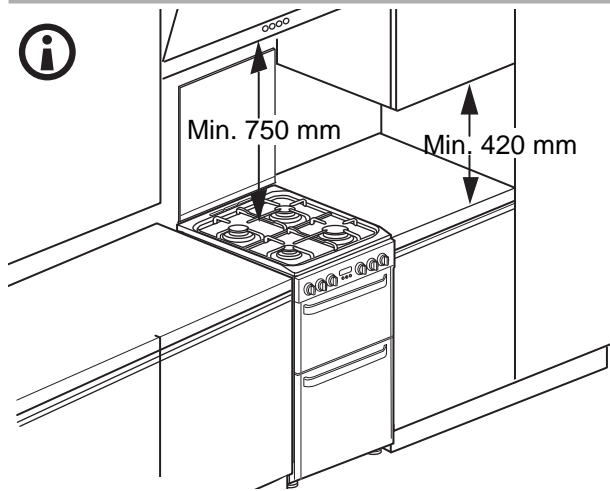
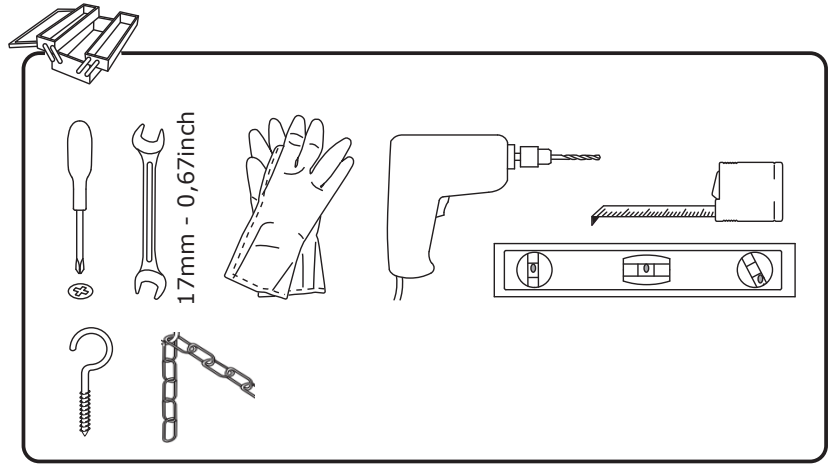

The height of the cooker can be adjusted by means of adjustable feet in the base of the product (900mm - 915mm). To allow alignment with a worktop height greater than 915mm (max 940mm), longer feet are supplied inside your new product. Tilt the the cooker from the side, and the feet can be screwed / unscrewed to achieve the desired height.

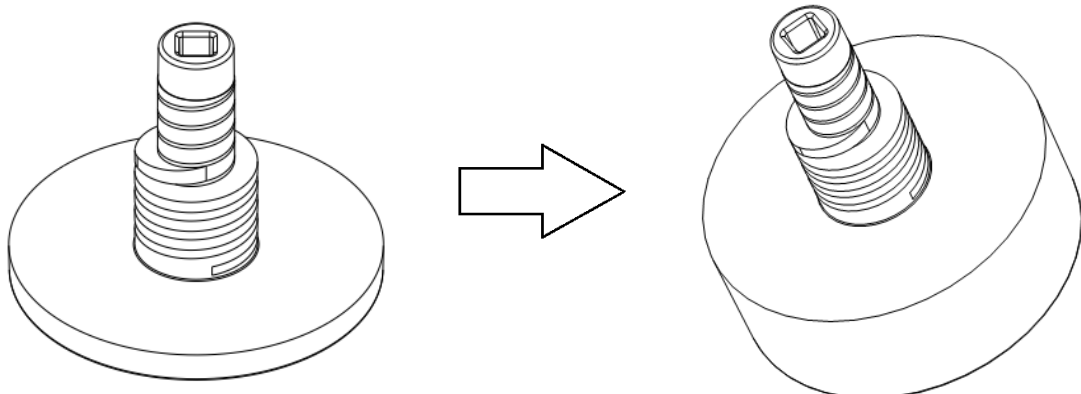

3

Connecting to gas supply

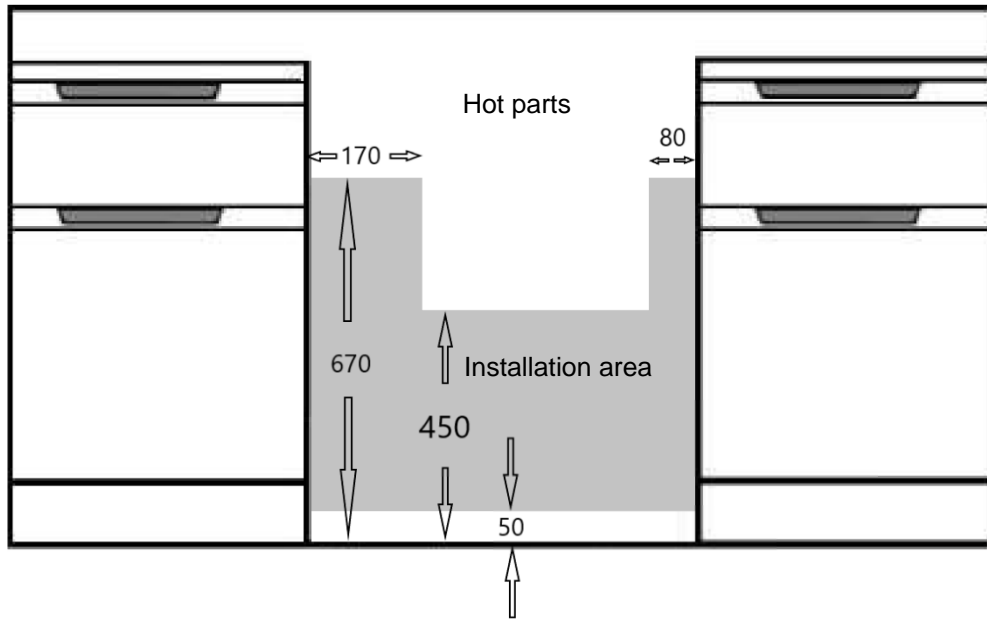

Position the gas connection point such that it is located within the shaded area, and the hose also hangs naturally within the shaded area.

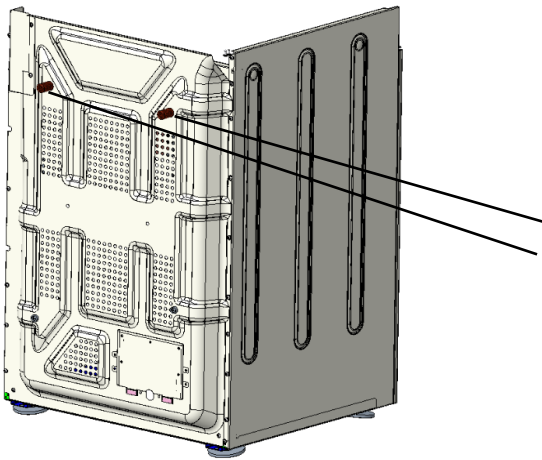

There are 2 spacers on the rear panel of the appliance (see Fig 1) intended to prevent the appliance trapping the flexible hose. If the flexible hose and its rigid pipework connections are recessed, the spacers can be removed by the installer to allow the appliance to be pushed back further in the aperture. This can only be done if the requirements of BS 6172:2010 can still be met.

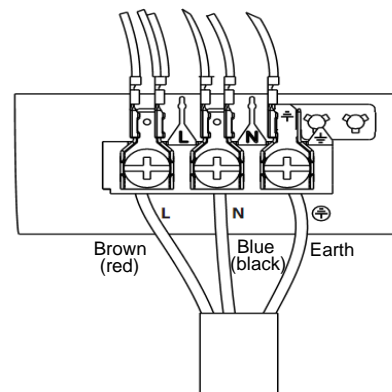

4

