



HDM67G0CMB/UK
HDM67G0CMBLPG

Hotpoint

EN *ENGLISH*

Health and Safety guide

Quick guide

Installation guide

EN

SAFETY INSTRUCTIONS

IMPORTANT TO BE READ AND OBSERVED

⚠ CAUTION : Use of the gas cooking appliance results in the production of heat, moisture and products of combustion in the room in which it is installed. Ensure that the kitchen is well ventilated, especially when the appliance is in use: keep natural ventilation holes open or install a mechanical ventilation device (mechanical extractor hood). Prolonged intensive use of the appliance may call for additional ventilation, such as opening a window, or more effective ventilation, for example increasing the level of mechanical ventilation (if possible).

⚠ Failure to follow the information in this manual exactly may cause a fire or explosion, resulting in property damage or personal injury.

Before using the appliance, read these safety instructions. Keep them nearby for future reference.

These instructions and the appliance itself provide important safety warnings, to be observed at all times. The manufacturer declines any liability for failure to observe these safety instructions, for inappropriate use of the appliance or incorrect setting of controls.

⚠ WARNING: The appliance and its accessible parts become hot during use. Care should be taken to avoid touching heating elements. Children less than 8 years of age must be kept away unless continuously supervised.

⚠ WARNING : Danger of fire : Do not store items on the cooking surfaces.

⚠ CAUTION : The cooking process has to be supervised. A short cooking process has to be supervised continuously.

⚠ WARNING: Leaving the hob unattended when cooking with fat or oil can be dangerous – risk of fire. NEVER try to extinguish a fire with water, but switch off the appliance and then cover the flames e.g. with a lid or a fire blanket.

⚠ Do not use the hob as a work surface or support. Keep clothes or other flammable materials away from the appliance, until all the components have cooled down completely - risk of fire.

⚠ Very young children (0-3 years) should be kept away from the appliance. Young children (3-8 years) should be kept away from the appliance unless continuously supervised. Children from 8 years old and above and persons with reduced physical, sensory or mental capabilities or lack of experience and knowledge can use this appliance only if they are supervised or have been given instructions on safe use and understand the hazards involved. Children must not play with the appliance. Cleaning and user maintenance must not be carried out by children without supervision.

⚠ CAUTION : In case of hotplate glass breakage:- shut immediately off all burners and any electrical heating element and isolate the appliance from the power supply; - do not touch the appliance surface; -do not use the appliance



The glass lid can break if it is heated. Turn off all burners before closing the lid. Do not shut the lid when burners are lit.

⚠ WARNING: The appliance and its accessible parts become hot during use. Care should be taken to avoid touching heating elements. Children less than 8 years of age must be kept away unless continuously supervised.

⚠ Never leave the appliance unattended during use.

⚠ Keep clothes or other flammable materials away from the appliance, until all the components have cooled down completely - risk of fire. Always be vigilant when cooking foods rich in fat, oil or when adding alcoholic beverages - risk of fire. Use oven gloves to remove pans and accessories. At the end of cooking, open the door with caution, allowing hot air or steam to escape gradually before accessing the cavity - risk of burns. Do not obstruct hot air vents at the front of the oven - risk of fire.

⚠ Exercise caution when the oven door is in the open or down position, to avoid hitting the door. When you place the rack inside, make sure that the stop is directed upwards and in the back of the cavity.

The ignition device shall not be operated for more than 15 seconds. If after 15 seconds the burner has not lit, stop operating the device and open the compartment door and/or wait at least 1 min before attempting a further ignition of the burner.

PERMITTED USE

⚠ CAUTION: The appliance is not intended to be operated by means of an external switching device, such as a timer, or separate remote controlled system.

⚠ This appliance is intended to be used in household and similar applications such as: staff kitchen areas in shops, offices and other working environments; farm houses; by clients in hotels, motels, bed & breakfast and other residential environments.

⚠ No other use is permitted (e.g. heating rooms).

⚠ This appliance is not for professional use. Do not use the appliance outdoors.

⚠ Do not store explosive or flammable substances (e.g. gasoline or aerosol cans) inside or near the appliance - risk of fire.

⚠ Use pots and pans with bottoms the same width as that of the burners or slightly larger (see

specific table). Make sure pots on the grates do not protrude beyond the edge of the hob.

⚠ Improper use of the grids can result in damage to the hob: do not position the grids upside down or slide them across the hob.

Do not let the burner flame extend beyond the edge of the pan

Do not use : Cast iron griddles, ollar stones, terracotta pots and pans. Heat diffusers such as metal mesh, or any other types. Two burners simultaneously for one receptacle (e.g. Fish kettle).

Should particular local conditions of the delivered gas make the ignition of burner difficult, it is advisable to repeat the operation with the knob turned to small flame setting.

In case of installation of a hood above the cooktop, please refer to the hood instructions for the correct distance.

The protective rubber feet on the grids represent a choking hazard for young children. After removing the grids, please ensure that all the feet are correctly fitted. (in certain models only)

INSTALLATION

⚠ We recommend the appliance should be handled and installed by two or more persons - risk of injury. Use protective gloves to unpack and install - risk of cuts.

⚠ The electrical and gas connections must comply with local regulation.

⚠ Installation, electrical connections and repairs must be carried out by a qualified technician. Do not repair or replace any part of the appliance unless specifically stated in the user manual. Keep children away from the installation site. After unpacking the appliance, make sure that it has not been damaged during transport. In the event of problems, contact the dealer or your nearest Aftersales Service. Once installed, packaging waste (plastic, styrofoam parts etc.) must be stored out of reach of children - risk of suffocation. The appliance must be disconnected from the power supply before any installation operation - risk of electric shock. During installation, make sure the appliance does not damage the power cable - risk of fire or electric shock. Only activate the appliance when the installation has been completed.

⚠ **WARNING** : Modification of the appliance and its method of installation are essential in order to use the appliance safely and correctly in all the additional countries

⚠ Use pressure regulators suitable for the gas pressure indicated in the instruction.

⚠ The room must be equipped with an air extraction system that expels any combustion fumes.

⚠ Liquid petroleum gas sinks to the floor as it is heavier than air. Therefore, rooms containing LPG cylinders must also be equipped with vents to allow gas to escape in the event of a leak. This means LPG cylinders, whether partially or completely full, must not be installed or stored in rooms or storage areas that are below ground level (cellars, etc.). It is advisable to keep only the cylinder being used in the room, positioned so that it is not subject to heat produced by external sources (ovens, fireplaces, stoves, etc.) which could raise the temperature of the cylinder above 50°C.

Should you find it difficult to turn the knobs for the burner, please contact the After-sales Service, who can replace of the burner tap if found to be faulty.

The openings use for the ventilation and dispersion of heat must never be covered.

GAS CONNECTION

⚠ **WARNING** : Prior to installation, ensure that the local distribution conditions (type of gas and gas pressure) and the configuration of the appliance are compatible.

⚠ Check that the pressure of the gas supply is consistent with the values indicated in Table 1 ("Burner and nozzle specifications").

⚠ **WARNING** : The configuration conditions of this appliance are stated on the label (or data plate).

⚠ **WARNING** : This appliance is not connected to a combustion products evacuation device. It must be installed and connected in accordance with current installation regulations. Particular attention must be paid to the relevant requirements regarding ventilation.

⚠ If the appliance is connected to liquid gas, the regulation screw must be adjusted to the minimum setting.

⚠ **IMPORTANT** : When the gas cylinder or gas container is installed, it must be properly settled (vertical orientation).

⚠ **WARNING** : This operation must be performed by a qualified technician

⚠ The appliance should be connected to the main gas supply or to a gas cylinder in compliance with the current national regulations. Before making the connection, make sure that the appliance is compatible with the gas supply you wish to use. If it is not, follow the instructions indicated in the paragraph "Adapting to different types of gas".

⚠ After connection to the gas supply, check for leaks in accordance with IGEM/UP/1B. Light up the burners and turn the knobs from max position 1* to minimum position 2* to check flame stability.

⚠ Connection to the gas network or the gas cylinder may be carryout using a flexible rubber or steel hose, in accordance with current national legislation.

ADAPTING TO DIFFERENT TYPES OF GAS

(This operation needs to be carried out by a qualified technician.)

⚠ In order to adapt the appliance to a type of gas other than the type for which it was manufactured (indicated on the rating label), follow the dedicated steps provided after installation drawings.

ELECTRICAL WARNINGS

⚠ **IMPORTANT:** Information about current and voltage consumption is provided on the rating plate.

⚠ The rating plate is on the front edge of the oven (visible when the door is open).

⚠ It must be possible to disconnect the appliance from the power supply by unplugging it if plug is accessible, or by a multi-pole switch installed upstream of the socket in accordance with the wiring rules and the appliance must be earthed in conformity with national electrical safety standards.

⚠ The power cable must be long enough to connect the appliance, once fitted in its housing, to the main power supply. Do not pull the power supply cable.

⚠ Do not use extension leads, multiple sockets or adapters. The electrical components must not be accessible to the user after installation. Do not use the appliance when you are wet or barefoot. Do not operate this appliance if it has a damaged power cable or plug, if it is not working properly, or if it has been damaged or dropped.

⚠ If the supply cord is damaged, it must be replaced with an identical one by the manufacturer, its service agent or similarly qualified persons in order to avoid a hazard - risk of electric shock.

⚠ If the power cable needs to be replaced, contact an authorised service centre.

CLEANING AND MAINTENANCE

⚠ **WARNING:** Ensure that the appliance is switched off and disconnected from the power supply before performing any maintenance operation; never use steam cleaning equipment - risk of electric shock.

⚠ Do not use harsh abrasive cleaners or metal scrapers to clean the door glass since they can scratch the surface, which may result in shattering of the glass.

⚠ Do not use abrasive or corrosive products, chlorine-based cleaners or pan scourers.

⚠ Make sure the appliance has cooled down before cleaning or performing maintenance. - risk of burns.

⚠ **WARNING:** Switch off the appliance before replacing the lamp - risk of electric shock.

⚠ To avoid damaging the electric ignition device, do not use it when the burners are not in their housing.

Wear protective gloves for cleaning and maintenance.

DISPOSAL OF PACKAGING MATERIALS

The packaging material is 100 % recyclable and is marked with the recycle symbol .

The various parts of the packaging must therefore be disposed of responsibly and in full compliance with local authority regulations governing waste disposal .

DISPOSAL OF HOUSEHOLD APPLIANCES

This appliance is manufactured with recyclable or reusable materials. Dispose of it in accordance with local waste disposal regulations . For further information on the treatment, recovery and recycling of household household electrical appliances, contact your local authority, the collection service for household waste or the store where you purchased the appliance.

This appliance is marked in compliance with The European Directive 2012/19/EU, Waste Electrical and Electronic Equipment (WEEE) and with the Waste Electrical and Electronic Equipment regulations 2013 (as amended) . By ensuring this product is disposed of correctly , you will help prevent negative consequences for the environment and human health . The ed , symbol  on the product or on the accompanying documentation indicates that it should not be treated as domestic waste but must be taken to an appropriate collection centre for the recycling of electrical and electronic equipment.

ENERGY SAVING TIPS

Only preheat the oven if specified in the cooking table or your recipe. Use dark lacquered or enamelled dark lacquered or enamelled baking trays as they absorb heat better. Use a pressure cooker to save even more energy and time.

DECLARATION OF CONFORMITY

This appliance meets: Ecodesign requirements of European Regulation 66/2014; Energy Labelling Regulation 65/2014; Ecodesign for Energy-Related Products and Energy Information (Amendment) (EU Exit) Regulations (2019), in compliance with the European standard: EN 15181. This appliance meets Ecodesign requirements of European Regulation 66/2014 and the Ecodesign for Energy-Related Products and Energy Information (Amendment) (EU Exit) Regulations 2019 in compliance with the European standard EN 30-2-1.

PRODUCT DESCRIPTION

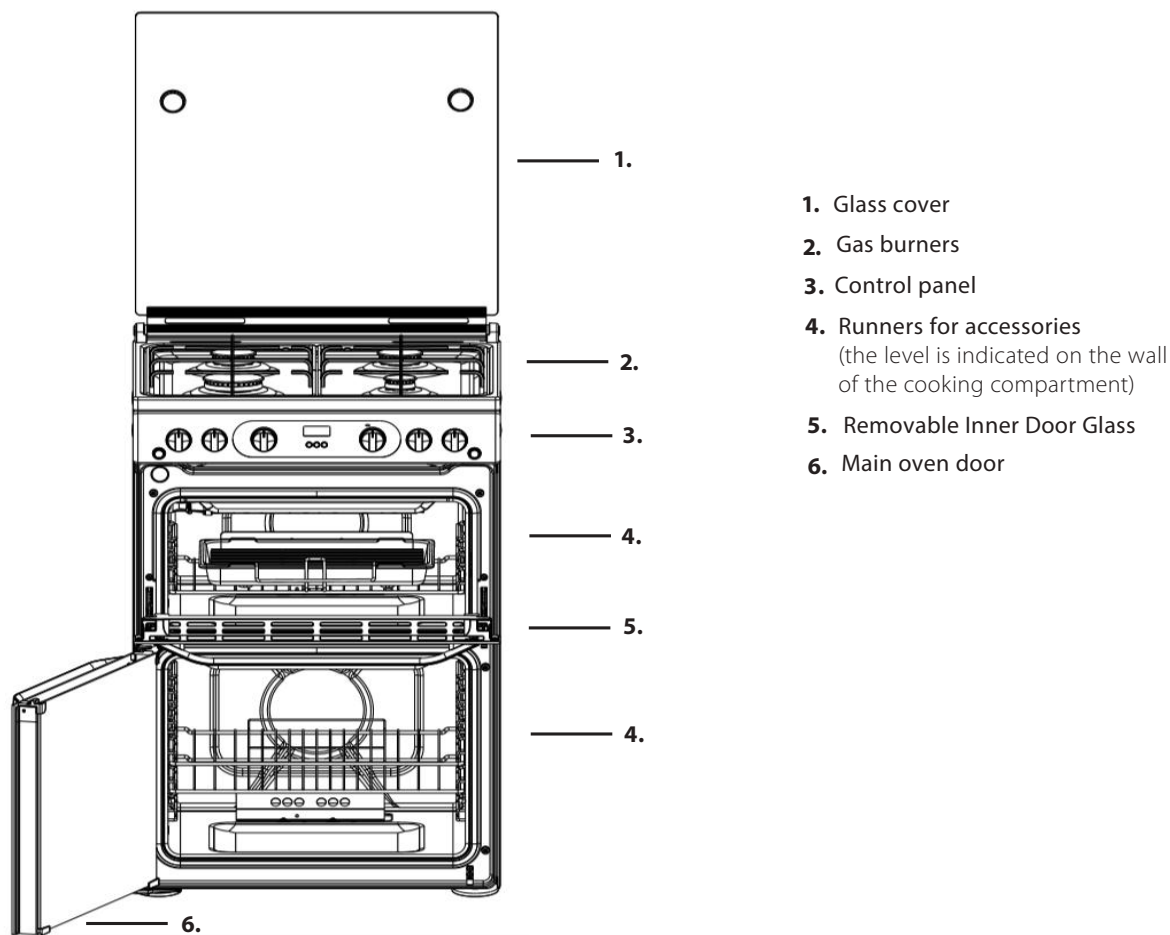

- 1. Glass cover
- 2. Gas burners
- 3. Control panel
- 4. Runners for accessories
(the level is indicated on the wall of the cooking compartment)
- 5. Removable Inner Door Glass
- 6. Main oven door

CONTROL PANEL

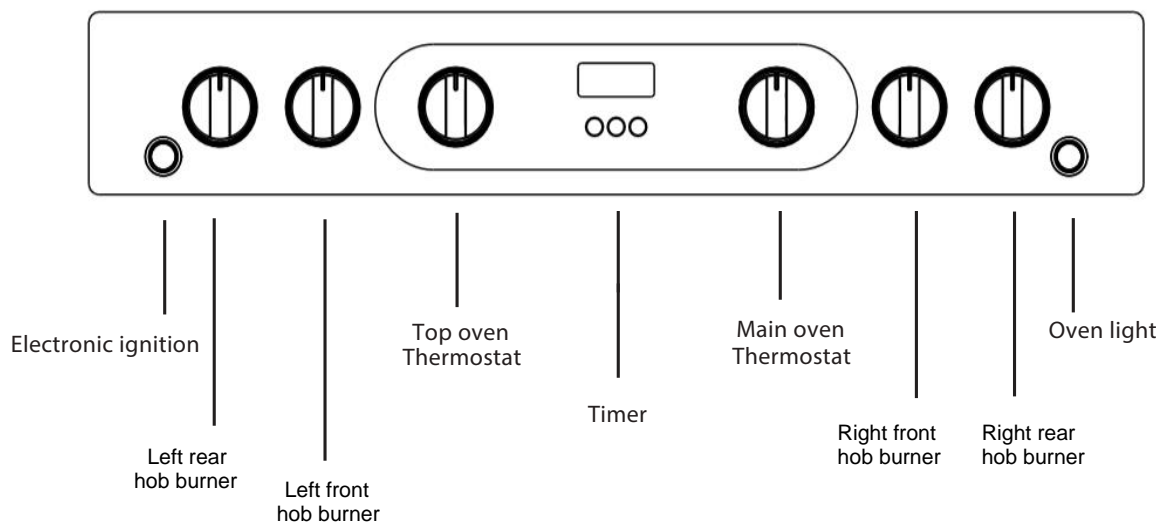

Electronic ignition

Left rear
hob burner

Left front
hob burner

Top oven
Thermostat

Timer

Main oven
Thermostat

Right front
hob burner

Right rear
hob burner

Oven light

⚠ WARNING : This operation must be performed by a qualified technician

Before moving your cooker check that it is cool, and switch off at the cooker control unit. Movement of your cooker is most easily achieved by lifting the front as follows:

Open the grill door sufficiently to allow a comfortable grip on the underside front edge of the oven roof, avoiding any grill elements. (FIG.A)

Take care in moving the cooker as it is heavy. Take care to ensure that any floor covering is not damaged.

Splashplate optional, apply to Parts Department (see Back Cover for contact number.)

The following instructions should be read by a qualified technician to ensure that the appliance is installed, regulated and technically serviced correctly in compliance with current regulations.

Positioning

This unit may be installed and used only in permanently ventilated rooms according to the British Standards Codes Of Practice: BS 5440 Part 2 The following requirements must be observed:

- The cooker should not be installed in a bed sitting room with a volume of less than 20m³. If it is installed in a room of volume less than 5m³ an air vent of effective area of 100cm² is required, if it is installed in a room of volume between 5m³ and 10m³ a supplementary airvent area of 50cm² is required, if the volume exceeds 10m³ no airvent is required. However, if the room has a door or a window which opens directly to the outside no air vent is required even when the volume is between 5m³ and 10m³. The room containing the appliance must contain an openable window or an acceptable alternative such as an adjustable louvre or hinged panel opening direct to outside air.
- During prolonged use of the appliance you may consider it necessary to open a window to the outside to improve ventilation.
- If there are other fuel burning appliances in the same room, B.S.5440 Part 2 Current Edition, should be consulted to determine the requisite air vent.

Installation of the cooker

For a correct installation of the cooker the following precautions must be followed:

The height of the cooker can be adjusted by means of adjustable feet in the base of the product (900mm - 915mm). To allow alignment with a worktop of greater than 915mm (max 940mm), longer adjustable feet are available as a spare part on request.

Adjust the feet by tilting the cooker from the side. Then install the product into position.

NOTE: This appliance must not be fitted on a platform.

The cooker is designed to fit between kitchen cabinets spaced 600mm apart. The space either side need only be sufficient to allow withdrawal of the cooker for servicing. It can be used with cabinets one side or both as well as in a corner setting. It can also be used free-standing. Adjacent side walls which project above hob level, must not be nearer to the cooker than 65mm and should be protected by heat resistant material. Any overhanging surface or cooker hood should not be nearer than 750mm.

- The cooker may be located in a kitchen, a kitchen/diner or bed sitting room, but not in a bathroom or shower room.
- The hoods must be installed according to the requirements in the hood handbook (minimum 750mm)
- The wall behind the cooker, 50mm below and 450mm above, and the width of the cooker, must be a noncombustible material such as ceramic wall tiles.
- The cooker should be secured to the wall behind via a safety chain and hook. (fig.B)



Moving the Cooker

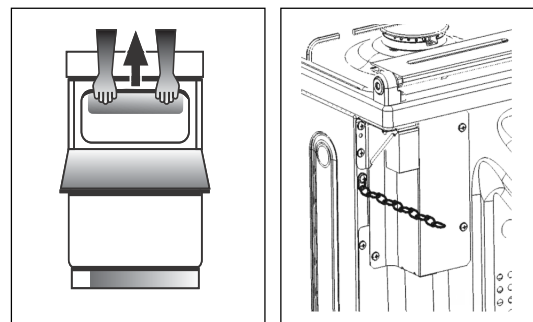

Fig. A

Fig. B

INSTALLATION TIPS

⚠ WARNING : This operation must be performed by a qualified technician

Gas connection

The cooker should be connected to the gas-supply by a gas safe registered installer. Connection of the appliance to the gas mains or liquid gas must be carried out according to the prescribed regulation in force, and only after it is ascertained that it is adaptable to the type of gas to be used. If not, follow the instructions indicated in the paragraph headed "Adaptation to different gas types". In the case of connection to liquid gas, by tank, use pressure regulators that conform to the regulation in force. The gas supply must be connected to the left of the appliance. Be sure that the hose does not pass through the rear of the cooker touching hot parts.

Make sure the supply pressure conforms with the values shown in the table entitled "Characteristics of the burners and nozzles".

When the cooker is installed between cabinets (recessed), the gas connection must be effected by an approved flexible hose with bayonet fitting (BS 669 or EN 14800). The gas inlet for the cookers is a threaded G 1/2 gas female fitting.

Connecting the gas supply

To make the connection, a flexible hose should be used corresponding to the current gas regulations which are:

- the hose must never be at any point in its length in contact with the "hot" parts of the cooker;
- the hose must never be longer than 1,5 metre;
- the hose must not be subject to any tension or torsional stress and it must not have any excessively narrow curves or bottlenecks;
- the hose must be easy to inspect along its entire length to check its condition;
- the hose must always be in good condition, never attempt to repair.

Adapting the cooker to different types of gas

In order to adapt the cooker to a different type of gas with respect to the gas for which it was produced follow these steps:

a) replace the hose holder mounted on the appliance with that supplied in the bag of "cooker accessories".

b) Replacing the burner nozzles on the hob:

- remove the grids and slide the burners from their housings;
- unscrew the nozzles using a 7 mm socket spanner, and replace them with nozzles for the new type of gas (see table 1 "Burner and nozzle characteristics").

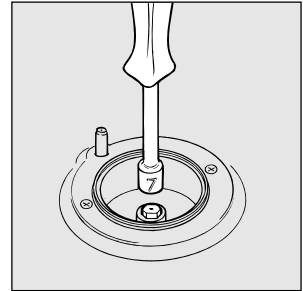

- replace all the components by repeating the steps in reverse order.

c) Minimum regulation of the hob burners:

- turn the tap to minimum;
- remove the knob and adjust the regulation screw, which is positioned in or next to the tap pin, until the flame is small but steady.

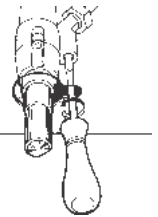

In the case of liquid gas, the regulation screw must be adjusted to the minimum setting.

- check that the flame does not turn off when you turn the tap quickly from high to low.

d) Regulating the primary air of the burners: The primary air of the burners requires no regulation.

On completion of the operation, replace the old rating sticker with one indicating the new type of gas used.

INSTALLATION TIPS

⚠ WARNING : This operation must be performed by a qualified technician

Adapting to different types of gas (main and top oven)

In order to adapt the oven to a different type of gas with respect to the gas for which it was manufactured (indicated on the label), follow these simple steps:

- a)** Replacing the oven burner nozzle
- open the oven door fully
 - pull out the sliding oven bottom
 - **unscrew the two screws and take off the shield protecting the burner (in main oven burner only).**

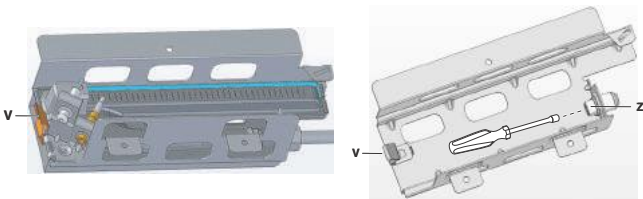

- Pry the fixing tab "V" and remove the oven burner
- Unscrew the oven burner nozzle using the socket spanner for the nozzles "Z", or a 7 mm socket spanner, and replace it with a nozzle suited to the new type of gas (see Table 1).

Take particular care handling the spark plug wires and the thermocouple pipes.

- Replace all the parts, following the steps described above in the reverse order.
- b)** Minimum regulation of the main and top gas oven burner with thermostat:
- light the burner as described in the paragraph "the oven knob" of the instruction booklet.
 - turn the knob to **Max** for about 10 minutes and then turn the knob to the **Min** setting;
 - remove the knob;
 - regulate the screw positioned outside the thermostat pin until the flame is small but steady.

In the case of liquid gas, the regulation screw must be screwed in to the bottom.

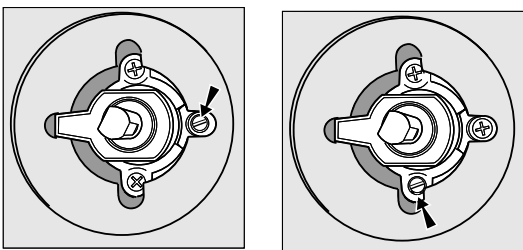

- check that the burner does not turn off **when** you turn the knob from Max to Min and and when you open and close the oven door quickly.

If the appliance is connected to a liquid gas supply, the bypass screw must be set to a minimum.

While the burner is alight, quickly change the position of the knob from minimum to maximum and vice versa several times, checking that the flame is not extinguished.

Upon completion of adjustment, reseal using sealing wax or an equivalent material.

Adapting the gas grill to different types of gas Replacing the nozzle of the grill burner:

1. Remove the enamelled baffle at the front of the grill (2 screws).
2. Remove the screw on the right hand side of the burner and gently slide the burner off the injector.
3. Using a 7mm socket, replace the grill injector as appropriate (see table on previous page).
4. Re-assemble the burner and baffle.

On completion of the operation, replace the old rating sticker with one indicating the new type of gas used. This sticker is available from our Service Centres.

Note

Should the pressure of the gas used be different (or vary) from the recommended pressure, it is necessary to fit a suitable pressure regulator onto the inlet pipe in compliance with current National Regulations relative to "regulators for channelled gas".

ELECTRICAL CONNECTION

⚠ WARNING : This operation must be performed by a qualified technician

Power supply voltage and frequency: 230-240V a.c.
50-60 Hz.

The supply cable must be positioned so that it never reaches at any point a temperature 50°C higher than the room temperature. The cable must be routed away from the rear vents. Should you require it, you may use a longer cable, however, you must ensure that the cable supplied with the appliance is replaced by one of the same specifications in accordance with current standards and legislation. Your appliance is supplied with a 13 amp fused plug that can be plugged into a 13 amp socket for immediate use. Before using the appliance please read the instructions below.

Replacing the fuse:

When replacing a faulty fuse, a 13 amp ASTA approved fuse to BS 1362 should always be used, and the fuse cover re-fitted. If the fuse cover is lost, the plug must not be used until a replacement is obtained.

Replacement fuse covers:

If a replacement fuse cover is fitted, it must be of the correct colour as indicated by the coloured marking or the colour that is embossed in words on the base of the plug. Replacements can be obtained directly from your nearest Service Depot.

Removing the plug:

If your appliance has a non-rewireable moulded plug and you should wish to remove it to add a cable extension or to re-route the mains cable through partitions, units etc., please ensure that either:

- the plug is replaced by a fused 13 amp re-wireable plug bearing the BSI mark of approval.
- or:
- the mains cable is wired directly into a 13 amp cable outlet, controlled by a switch, (in compliance with BS 5733) which is accessible without moving the appliance.

For appliances with a rating greater than 13 amp (eg: electric hob, double ovens and freestanding electric cookers etc.) the mains cable must be wired into a cooker output point with a rating of 45 amp. In this case the cable is not supplied.

Disposing of the plug:

Ensure that before disposing of the plug itself, you make the pins unusable so that it cannot be accidentally inserted into a socket. Instructions for connecting cable to an alternative plug:
The wires in the mains lead are coloured in accordance with the following code:

Green & Yellow - Earth
Blue - Neutral
Brown - Live

If the colours of the wires in the mains lead do not correspond with the coloured markings identifying the terminals in your plug, proceed as follows:
Connect Green & Yellow wire to terminal marked "E" or 6 or coloured Green or Green & Yellow.
Connect Brown wire to terminal marked "L" or coloured Red.

Connect Blue wire to terminal marked "N" or coloured Black.

If a 13 amp plug (BS 1363) is used it must be fitted with a 13 amp fuse. A 15 amp plug must be protected by a 15 amp fuse, either in the plug or adaptor or at the distribution board. If you are in any doubt about the electrical supply to your machine, consult a qualified electrician before use.

How to connect an alternative plug:

The wires in this mains lead are coloured in accordance with the following code:

BLUE "NEUTRAL"
("N")
BROWN "LIVE"
("L")
GREEN AND YELLOW "EARTH"
("E")

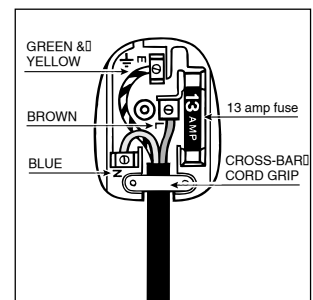

WARNING.

If the electric supply fails to this appliance you must not use the grill or ovens.

GRID



KIT GRILL PAN



The number and type of accessories may vary depending on which model is purchased. Other accessories that are not supplied can be purchased separately from the After-sales Service.

FIRST TIME USE DAILY USE

Using the hob

Lighting the burners

For each BURNER knob there is a complete ring showing the strength of the flame for the relevant burner.

To light one of the burners on the hob:

1. Bring a flame or gas lighter close to the burner.
2. Press the BURNER knob and turn it in an anticlockwise direction so that it is pointing to the maximum flame setting **▲**.
3. Adjust the intensity of the flame to the desired level by turning the BURNER knob in an anticlockwise direction. This may be the minimum setting **▲**, the maximum setting **▲** or any position in between the two.

Electronic Ignition for the Gas Hob

To light a specific burner just press the appropriate button on control panel while pushing the corresponding knob all the way in and turning it counter-clockwise until it lights. For immediate lighting, first press the button and then turn the knob.

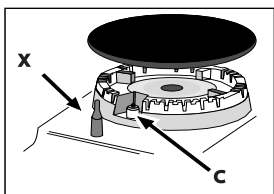

Since the hob burners are equipped with a safety device (X), press and hold the BURNER knob

for approximately 3-7 seconds to keep the flame alight and to activate the device.

If the flame is accidentally extinguished, switch off the burner and wait for at least 1 minute before attempting to relight it.

To switch the burner off, turn the knob until it reaches the stop position **●**.

Advice when using burners

For the burners to work in the most efficient way possible and to save on the amount of gas consumed, it is recommended that only pans which have a lid and a flat base are used. They should also be suited to the size of the burner.

| Burner | Ø Cookware diameter (cm) |
|---------------|--------------------------|
| Fast (R) | 24 - 26 |
| Semi Fast (S) | 16 - 20 |
| Auxiliary (A) | 10 - 14 |

To identify the type of burner, please refer to the diagrams contained in the paragraph "Burner and nozzle specifications."

For models equipped with a reducer grid, the latter must be used only for the auxiliary burner, when pans with a diameter of less than 12 cm are used.

| LEVEL | COOKING TIPS |
|-----------|--|
| 1 - 2 - 3 | Ideal for softening butter, gently melting chocolate in bagnemarie, thawing small portions, creaming risotto, keeping warm small portions of just-cooked preparation |
| 4 - 5 | Ideal for slow-cook recipes (rice, sauces, roast, fish) using liquids (water, wine, broth), and for creaming pasta, maintaining a gentle boiling |
| 6 - 7 | Ideal for sautéing, stewing vegetables, cooking for longer period, preheating accessories, cooking until creamy |
| 8 - 9 | Ideal for browning, starting to cook, bringing liquids to the boil quickly, frying deep-frozen products, grilling meat and fish, maintaining a lively boil |
| 10 | Ideal for rapidly increasing the temperature of food or for heating up liquids (water) |

FIRST TIME USE

DAILY USE

MAIN OVEN

TO USE THE MAIN OVEN

1. Place the oven shelves in the appropriate positions
2. Turn the burner knob in an anticlockwise direction so that it is pointing to the 9. step flame setting.
For the models with the electronic ignition button (★), press the button and then turn the knob.
3. Turn the control knob clockwise to the required setting.
4. Ensure that the appliance is connected to the correct electrical supply and that the supply is switched on.
5. To turn off, turn the control knob fully clockwise the the symbol **O**.

The control system for the main oven may be different to your previous appliance. To maintain a constant temperature, and give you the best results, the burner switches off once the set temperature is reached and then relights when the temperature drops. This means you will hear the ignition sequence on a regular basis during cooking.

If for any reason the oven burner has not lit after 15 seconds, turn the control knob to the OFF position. Leave the main oven door open and wait for at least 1 minute before attempting to light the burner again. Never place dishes over the burner. An odour may be noticed when first using the oven - this should cease after a short period of use.

RELIGHTING THE BURNER

In the event of the burner flames being accidentally extinguished, turn off the burner control and do not attempt to re-ignite the burner for at least one minute.

COLD START COOKING

Anything requiring long slow cooking such as casseroles and rich fruit cakes can be put into a cold oven. Satisfactory results can also be obtained with creamed mixture, rich pastries or yeast mixtures, but for perfection we recommend preheating the oven for about 15 minutes at the gas mark you require for cooking.

TOP OVEN

The top oven can be used to cook small quantities of food or used in conjunction with the main oven to provide additional cooking space.

The top oven is fitted with a safety device that will cut off the gas supply to the burner if the flame is extinguished for any reason. Each time the top oven is used, the safety device has to be activated by pushing and holding in the control knob for 3 seconds after the gas has lit.

A gentle flow of air will be blown from underneath the control panel when the grill or top oven is in use. If the fan fails to blow air when the top oven is in use, you must stop using and switch off the oven burner immediately and contact our service department.

The maximum size of baking tray that should be used is 300mm x 350mm (12" x 14").

TO USE THE TOP OVEN

1. Place the top oven shelf in the appropriate position
2. Ensure that the appliance is connected to the correct electrical supply and switched on
3. Push in and turn the control knob fully anticlockwise. Continue to push in the control knob for a further 3 seconds after the gas has lit to allow time for the safety device to operate. If the burner extinguishes when the control knob is released, repeat the procedure ensuring the control knob is fully depressed and allowing more time for the safety device to operate.

For the models with the electronic ignition button (★), press the button and then turn the knob.

4. Turn the control knob clockwise to the required setting. (refer to cooking chart).
5. To turn off, turn the control knob clockwise to the symbol **O**.

Always push the door firmly closed to ensure that there is no loss of heat through the door seal.

If for any reason the oven burner has not lit after 15 seconds, turn the control knob to the OFF position. Leave the top oven door open and wait for at least 1 minute before attempting to light the burner again.

1. Best results are obtained by pre-heating the oven for about 15 minutes.
2. Food which is higher than or will rise above 125mm (5") cannot be cooked in the top oven.

Never place dishes over the burner.

An odour may be noticed when first using the oven - this should cease after a short period of use.

RELIGHTING THE BURNER

In the event of the burner flames being accidentally extinguished, turn off the burner control and do not attempt to re-ignite the burner for at least one minute.

When the cooker is first used an odour may be emitted, this will cease after a period of use.

When first using the cooker ensure that the room is well ventilated (e.g. open a window or use an extractor fan) and that persons who may be sensitive to the odour avoid any fumes. It is suggested that any pets be removed from the room until the smell has ceased. This odour is due to temporary finish on oven liners and elements and also any moisture absorbed by the insulation.

GAS NOZZLE TABLE

Characteristics of the gas section

| Model | Gas section | |
|---------------|--------------|---|
| | Gas category | Rated power kW (1) |
| HDM67G0CMB/UK | II2H3+ | 14,30 (G20) 14,10 (1025 g/h-G30) (1007 g/h-G31) |

(1) The values in g/h refer to the capacities with liquid gas (Butane, Propane).

Table 1

| Burner | Diameter (mm) | Liquid Gas | | | | | | Natural Gas | | | |
|-----------------------|--|----------------------------|---------|--------------------|-------------------|-------------------|----------------|----------------------------|---------|-------------------|----------------|
| | | Thermal Power kW (p.c.s.*) | | By-Pass 1/100 (mm) | Nozzle 1/100 (mm) | Flow* g/h | | Thermal Power kW (p.c.s.*) | | Nozzle 1/100 (mm) | Flow* l/h |
| | | Nominal | Reduced | | | *** | ** | Nominal | Reduced | | |
| Fast (Large)(R) | 100 | 3.0 | 0.7 | 41 | 86 | 218 | 214 | 3.0 | 0.7 | 116 | 286 |
| Semi Fast (Medium)(S) | 75 | 2.0 | 0.4 | 30 | 70 | 145 | 143 | 2.0 | 0.4 | 103 | 190 |
| Auxiliary (Small)(A) | 55 | 1.0 | 0.4 | 30 | 50 | 73 | 71 | 1.0 | 0.4 | 79 | 95 |
| Main Oven | - | 2.6 | 0.6 | 36 | 77 | 167 | 164 | 2.6 | 0.6 | 120 | 248 |
| Grill | - | 3.5 | - | - | 96 | 247 | 243 | 3.7 | - | 150(X) | 352 |
| Top Oven | - | 1.8 | 0.6 | 30 | 65 | 138 | 136 | 1.8 | 0.6 | 104 | 171 |
| Supply Pressures | Nominal (mbar) Minimum (mbar) Maximum (mbar) | | | | | 28-30 20 35 | 37 25 45 | | | | 20 17 25 |

* At 15°C and 1013 mbar - dry gas

*** Butane P.C.S. = 49,47 MJ/Kg

** Propane P.C.S. = 50,37 MJ/Kg

Natural P. C.S. = 37,78 MJ/m3

The front right hob burner injector should be used as the pressure test point.

GRILL

The grill is fitted with a safety device that will cut off the gas supply to the burner if the flame is extinguished for any reason. Each time the grill is used, the safety device has to be activated by pushing and holding in the control knob for 3 seconds after the gas has lit. A gentle flow of air will be blown from underneath the control panel when the grill or top oven is in use. If the fan fails to blow air when the grill is in use, you must stop using and switch off the grill burner immediately and contact our service department.

Do not use the grill without an electrical supply to the cooker.

Grill Pan Handle

The grill pan handle is detachable from the pan to facilitate cleaning and storage. Fix the pan handle securely before use:

1. Fit the handle to the grill pan so that the external 'hooks' embrace the edge of the pan (fig. 1)
2. Make sure that the middle part of the handle fits exactly the protruding support of the pan (fig. 2) and holds the pan from the bottom.

The food must be placed on the rack in the grill pan. Position the grill pan on top of the oven rack. The best results are achieved by placing the oven rack on the uppermost shelves. Pouring a little water into the grill pan will make the collection of grease particles more efficient and prevent the formation of smoke.

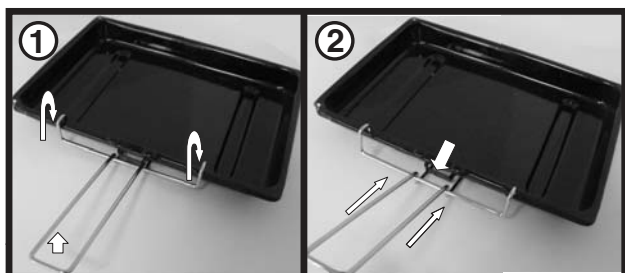

the handle attached by placing the shelf in the middle or lower position and tilting the grill pan over the rear edge of the shelf.

TO USE THE GRILL

1. Open the top oven/grill door and remove the grill pan.
2. Place the shelf in the appropriate position.
3. Ensure that the appliance is connected to the correct electrical supply and that the supply is switched on.
4. Push in and turn the control knob clockwise to the large flame symbol. Continue to push in the control knob for a further 3 seconds after the gas has lit,

to allow time for the safety device to operate. If the burner extinguishes when the control knob is released, repeat the procedure ensuring the control knob is fully depressed and allowing more time for the safety device to operate.

For the models with the electronic ignition button (★), press the button and then turn the knob.

5. Slide the grill pan along the shelf towards the rear of the grill compartment until it stops.
6. To turn off, turn the control knob anti-clockwise to the symbol ○.

The grill cannot be used at the same time as the top oven. If for any reason the grill burner has not lit after 15 seconds, turn the control knob to the off position, leave the grill door open and wait for at least one minute before attempting to light the burner again. An odour may be noticed when first using the grill this should cease after a short period of use.

Do not use the grill with the door closed. Do not cover the grill pan or grid with aluminium foil as this can hold fat, intensify the heat and create a fire hazard.

RELIGHTING THE BURNER

In the event of the burner flames being accidentally extinguished, turn off the burner control and do not attempt to re-ignite the burner for at least one minute. Grilling can be started from cold but for best results preheat for approximately two minutes. Most cooking is done with the heat on full, but it may be desirable to reduce it for thicker pieces of meat or for keeping food warm.

For au gratin dishes eg. Macaroni Cheese and meringue toppings eg. Baked Alaska, place the dish on the floor of the grill compartment. The base of the grill pan can be used for warming fruit garnishes on the reduced setting.

Always ensure that the grill pan handle is correctly fitted to the grill pan.

CLOCK/MINUTE MINDER OPERATION

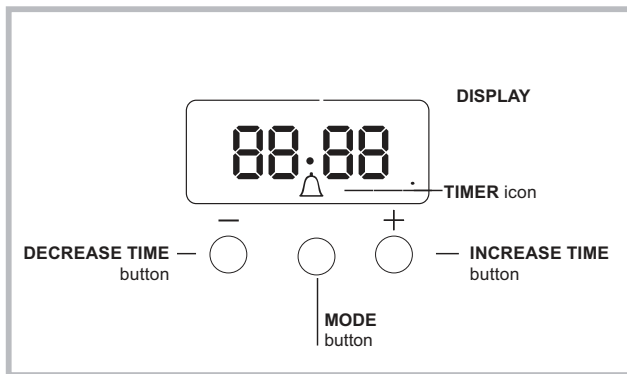

Setting the clock

The clock may be set when the oven is switched off or when it is switched on, provided that the end time of a cooking cycle has not been programmed previously. After the appliance has been connected to the mains,

or after a blackout, the 00:00 digits on the DISPLAY will begin to flash.

1. Press the "+" and "-" button simultaneously. Then the colon between hours and minutes is flashing.



2. Use the "+" and "-" buttons to adjust the time; if you press and hold either button, the display will scroll through the values more quickly, making it quicker and easier to set the desired value.

Changing the buzzer frequency

The buzzer signal frequency can be changed by touching the "-" repeatedly.



















Setting the minute minder

This function does not interrupt cooking and does not affect the oven; it is simply used to activate the buzzer when the set amount of time has elapsed.

1. Press the  button several times until the  icon and the three digits on the display begin to flash.
2. Use the "+" and "-" buttons to set the desired time; if you press and hold either button, the display will scroll through the values more quickly, making it quicker and easier to set the value.
3. Wait for 5 seconds. If you press the button one more time the display will then show the time as it counts down. When this period of time has elapsed the buzzer will be activated.









COOKING TABLE





MAIN OVEN

| RECIPE | FUNCTION | PREHEAT Time (minutes) | GAS MARK | DURATION (Minutes) | LEVEL (L-number) AND ACCESSORIES |
|---|--------------|------------------------|----------|--------------------|---|
| Leavened cakes / Sponge cakes | CONVENTIONAL | 10 | 3 - 4 | 20 - 50 | 3  |
| Filled cake (cheese cake, strudel, fruit pie) | CONVENTIONAL | 10 | 3 - 4 | 20 - 50 | 3  |
| Cookies / Shortbread | CONVENTIONAL | 5 | 2 - 3 | 50 - 70 | 3  |
| Small cakes / Muffin | CONVENTIONAL | 10 | 3 - 4 | 20 - 50 | 3  |
| Choux buns | CONVENTIONAL | 10 | 4 - 5 | 20 - 50 | 4  |
| Pizza / Bread / Focaccia Thin | CONVENTIONAL | 15 | 8 - 9 | 15 - 50 | 3  |
| Pizza / Bread / Focaccia Thick | CONVENTIONAL | 15 | 4 - 6 | 30 - 50 | 2  |
| Savoury pies (vegetable pie, quiche) | CONVENTIONAL | 10 | 4 | 40 - 60 | 2  |
| Vols-au-vent / Puff pastry crackers | CONVENTIONAL | 15 | 4 - 6 | 15 - 40 | 2  |
| Lasagne / Flans / Baked pasta / Cannelloni | CONVENTIONAL | 15 | 4 - 6 | 30 - 65 | 2  |
| Lamb / Veal / Beef / Pork 1 kg | CONVENTIONAL | 10 | 4 - 5 | 50 - 120 | 2  |
| Chicken / Rabbit / Duck 1 kg | CONVENTIONAL | 15 | 6 - 7 | 25 - 50 | 2  |
| Turkey / Goose 3 kg | CONVENTIONAL | 10 | 3 - 4 | 130 - 170 | 1  |
| Fish fillets / Steaks | CONVENTIONAL | 15 | 4 - 6 | 20 - 30 | 3  |
| Stuffed vegetables (tomatoes, courgettes, aubergines) | CONVENTIONAL | 15 | 4 - 6 | 40 - 80 | 3  |
| Vegetable gratin | CONVENTIONAL | 15 | 4 - 6 | 20 - 30 | 3  |
| Roast potatoes | CONVENTIONAL | 15 | 4 - 8 | 40 - 80 | 3  |
| Leg of lamb / Shanks | CONVENTIONAL | 15 | 6 - 8 | 50 - 100 | 3  |

COOKING TABLE

TOP OVEN

| RECIPE | FUNCTION | PREHEAT Time (Minutes) | GAS MARK | DURATION (Minutes) | LEVEL (L-number) AND ACCESSORIES |
|---|--------------|------------------------|----------|--------------------|---|
| Leavened cakes / Sponge cakes | CONVENTIONAL | 10' | 3 - 4 | 30 - 70 | 1  |
| Filled cake (cheese cake, strudel, fruit pie) | CONVENTIONAL | 10' | 3 | 150 - 250 | 1  |
| Cookies / Shortbread | CONVENTIONAL | 10' | 2 | 15 - 30 | 1  |
| Small cakes / Muffin | CONVENTIONAL | 10' | 3 - 4 | 15 - 30 | 1  |
| Choux buns | CONVENTIONAL | 10' | 4 - 5 | 20 - 50 | 1  |
| Pizza / Bread / Focaccia Thin | CONVENTIONAL | 15' | 7 - 8 | 15 - 30 | 2  |
| Pizza / Bread / Focaccia Thick | CONVENTIONAL | 15' | 4 - 6 | 30 - 50 | 2  |
| Savoury pies (vegetable pie, quiche) | CONVENTIONAL | 10' | 4 | 40 - 60 | 2  |
| Vols-au-vent / Puff pastry crackers | CONVENTIONAL | 15' | 4 - 6 | 15 - 40 | 2  |
| Lasagne / Flans / Baked pasta / Cannelloni | CONVENTIONAL | 15' | 4 - 6 | 30 - 65 | 2  |
| Lamb / Veal / Beef / Pork 1 kg | CONVENTIONAL | 10' | 4 - 5 | 50 - 120 | 2  |
| Chicken / Rabbit / Duck 1 kg | CONVENTIONAL | 15' | 6 - 7 | 25 - 50 | 2  |
| Fish fillets / Steaks | GRILL | 10' | MAX | 15 - 35 | 2  |
| Stuffed vegetables (tomatoes, courgettes, aubergines) | GRILL | 10' | MAX | 30 - 60 | 1  |
| Vegetable gratin | GRILL | 10' | MAX | 15 - 40 | 2  |
| Toast | GRILL | 10' | MAX | 3 - 5 | 2  |
| Sausages / Kebabs / Spare ribs / Hamburgers | GRILL | 10' | MAX | 20 - 40 | 2  |
| Roast potatoes | CONVENTIONAL | 15' | 4 - 8 | 40 - 80 | 2  |
| Leg of lamb / Shanks | CONVENTIONAL | 15' | 6 - 8 | 50 - 100 | 1  |

| ACCESSORIES |  |  |  |  |  |
|-------------|---|---|---|---|---|
| | Wire shelf | Baking dish or cake tin on the wire shelf | Baking tray/Drip tray or Baking dish on the wire shelf | Drip tray / Baking tray | Drip tray / Baking tray with 500 ml of water |

CLEANING AND MAINTENANCE

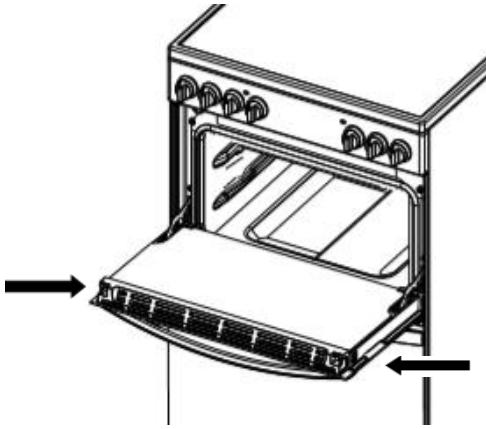

Cleaning the glass door with 2 panels

TOP OVEN DOORS

1.

Open the door to 30°. Removing the retaining bar depress carefully the clips on both sides of the bar. Pull the trim up gently until the retainer is released.

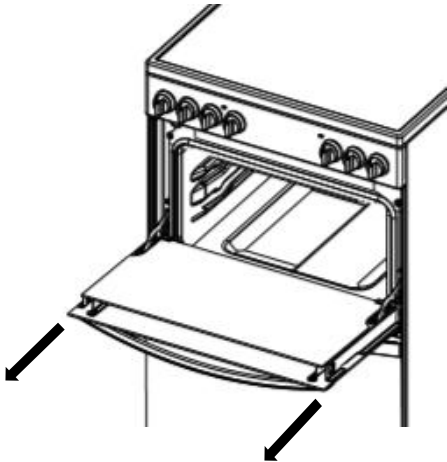

2.

Carefully slide the first inner glass towards you, taking care not to allow the glass to fall.

3.

Now the external glass panel can be washed.

Ensure the glass panel is not subjected to any sharp mechanical blows. Take particular care not to damage the inner surface which is coated with a heat reflective layer. After cleaning, rinse and dry with a soft cloth. For slight soiling the inner glass panel may be cleaned, while still warm, without removing it from the door.

Oven must not be operated with inner door glass removed.

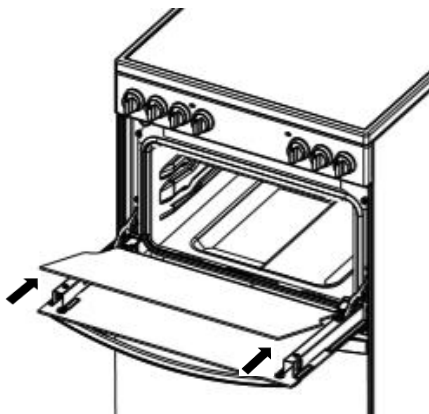

4.

To reassemble the oven doors proceed with inserting the glass panels in the reverse order, pushing gently every panel directly into the liners, so that the warning sign printed on the glass is correctly legible.

TURN OFF THE MAIN SWITCH AND ENSURE THE COOKER IS COLD BEFORE CLEANING.
BEFORE SWITCHING ON AGAIN, ENSURE THAT ALL CONTROLS ARE IN THE OFF POSITION.

Do not use steam cleaning equipment.

Use protective gloves during all operations.

Carry out the required operations when the oven is cold.

Disconnect the appliance from the power supply.

Do not use wire wool, abrasive scourers or abrasive/corrosive cleaning agents, as these could damage the surfaces of the appliance.

Disconnect the appliance from the power supply

CLEANING THE HOB SURFACE

All the enamelled and glass parts should be cleaned with warm water and neutral solution. Stainless steel surfaces may be stained by calcareous water or aggressive detergents if left in contact for too long. Any food spills (water, sauce, coffee, etc.) should be wiped away before they dry.

Clean with warm water and neutral detergent, and then dry with a soft cloth or chamois. Remove baked-on dirt with specific cleaners for stainless steel surfaces.

NOTE: clean stainless steel only with soft cloth or sponge.

Do not use abrasive or corrosive products, chlorine-based cleaners or pan scourers.

Do not use steam cleaning appliances.

Do not use flammable products.

Do not leave acid or alkaline substances, such as vinegar, mustard, salt, sugar or lemon juice on the hob.

CLEANING THE HOB PARTS

Clean glass and enamelled parts only with soft cloth or sponge. Grids, burner caps and burners can be removed to be cleaned.

Clean them by hand with warm water and non-abrasive detergent removing any food residues and checking that none of the burner openings is clogged.

Rinse and dry.

Refit burners and burner caps correctly in the respective housings.

When replacing the grids, make sure that the panstand area is aligned with the burner.

Models equipped with electrical ignition plugs and safety device require thorough cleaning of the plug end in order to ensure correct operation. Check these items frequently, and if necessary, clean them with a damp cloth. Any baked-on food should be removed with a toothpick or needle.

NOTE: to avoid damaging the electric ignition device, do not use it when the burners are not in their housing.

CLEANING THE OVEN SURFACE

EXTERIOR SURFACES

- Clean the surfaces with a damp microfibre cloth. If they are very dirty, add a few drops of pH-neutral detergent. Dry them with a dry cloth.
- Do not use corrosive or abrasive detergents. If any of these products inadvertently comes into contact with the surfaces of the appliance, clean immediately with a damp microfibre cloth.

INTERIOR SURFACES

- After every use, leave the oven to cool and then clean it, preferably while it is still warm, to remove any deposits or stains caused by food residues. To dry any condensation that has formed as a result of cooking foods with a high water content, let the oven to cool completely and then wipe it with a cloth or sponge.
- Clean the glass in the door with a suitable liquid detergent.

ACCESSORIES

Soak the accessories in a washing-up liquid solution after use, handling them with oven gloves if they are still hot. Food residues can be removed using a washing-up brush or a sponge.

REPLACING THE LIGHT

1. Disconnect the oven from the power supply.
2. Unscrew the cover from the light, replace the bulb and screw the cover back on the light.

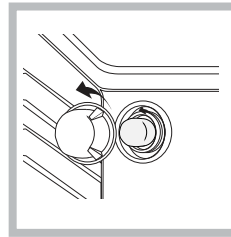

3. Reconnect the oven to the power supply.
Note: Use 40 W/230 V type G9

The bulb used in the product is specifically designed for domestic appliances and is not suitable for general room lighting within the home (EC Regulation 244/2009). Light bulbs are available from our After-sales Service.

- Do not handle bulbs with your bare hands as your fingerprints could damage them. Do not use the oven until the light cover has been refitted.

This product contains a light source of energy efficiency class G

LOWER THE TOP HEATING ELEMENT (Only in some models)

The top heating element of the grill can be lowered to clean the upper panel of the oven: Extract the heating element from its seating, then lower it. To return the heating element to its position, lift it up, pull it slightly towards you and make sure that the tab support is in its proper seating.

USEFUL TIPS

HOW TO READ THE COOKING TABLE

The table indicates the best function to use with certain types of food cooked on a single shelf. Cooking times start from the moment food is placed in the oven, excluding pre-heating (where required). Cooking temperatures and times are purely for guidance and will depend on the amount of food and type of accessory used. Use the lowest recommended settings to begin with and, if the food is not cooked enough, then switch to higher settings. Use the accessories supplied and preferably dark-coloured metal cake tins and baking trays. You can also use Pyrex pans and accessories or ones made from china, but bear in mind that cooking times will be slightly longer. For best results, follow the recommendations in the cooking table carefully when selecting which of the supplied accessories to place on which of the shelves.

TROUBLESHOOTING

| Problem | Possible cause | Solution |
|--|---|--|
| The oven or the burner will not switch on. | Power cut. Disconnection from the mains electricity. | Check for the presence of mains electrical power and whether the oven is connected to the electricity supply. Wait at least one minute, then try to switch the oven on again and see if the problem persists. |
| | Gas supply interrupted. | Check that the gas tap upstream of the oven is open or that the liquid gas cylinder (if being used) is not empty. |
| | Switch-on procedure carried out incorrectly. | Wait at least one minute and then repeat the steps described in the "Daily use" section. |

In the event of problems, turn the adjustment knob back to the 0 position and open the oven door.

AFTER-SALES SERVICE

To receive assistance, call the number given on the warranty leaflet enclosed with the product or follow the instructions on our website. Be prepared to provide:

- a brief description of the problem;
- the exact model type of your product;
- the assistance code (the number following the word SERVICE on the identification plate attached to the product, which can be seen on the inside edge when the oven door is open);
- your full address;
- a contact telephone number.

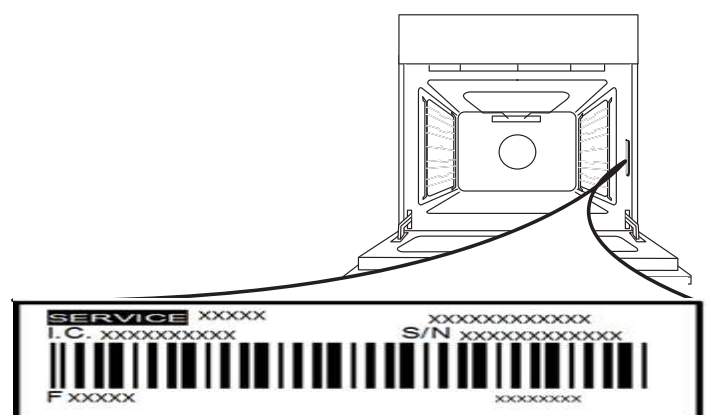

Please note: If repairs are required, contact an authorised service centre that is guaranteed to use original spare parts and perform repairs correctly.

Please refer to the enclosed warranty leaflet for more information on the warranty.

 [www](http://www.hotpoint.co.uk) A complete product specification, including the energy efficiency ratings for this oven, can be read and downloaded from our website www.hotpoint.co.uk

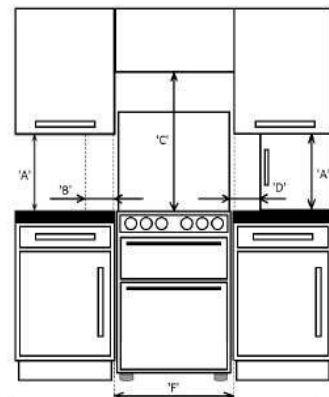
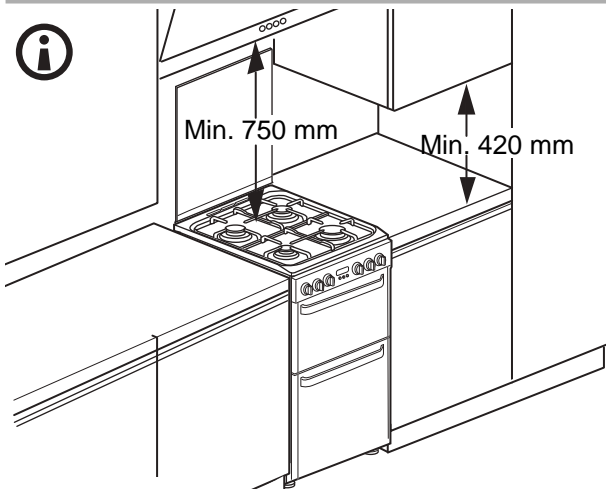
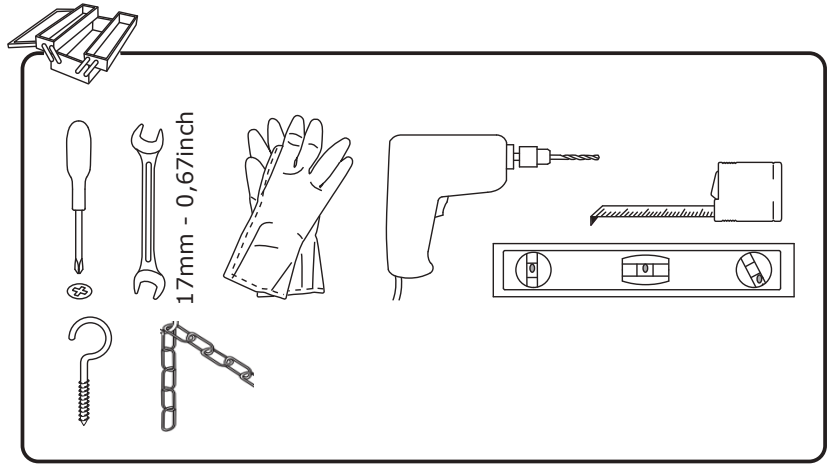
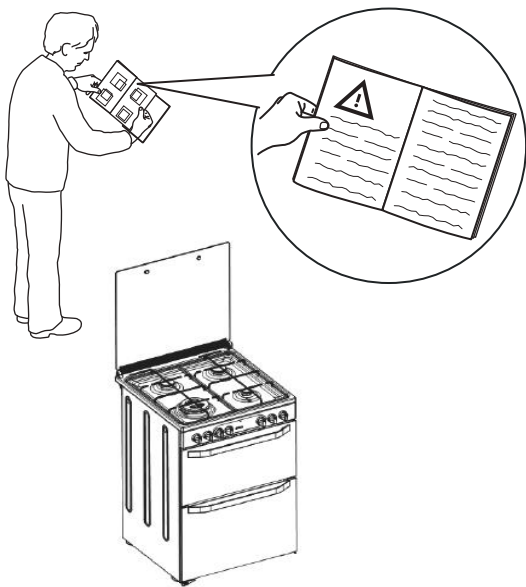

| 'A' | 'B' | 'C' | 'D' | 'F' |
|-----------|-----------|------------|-----------|-----------|
| 420mm Min | 65 mm Min | 750 mm Min | 65 mm Min | 600mm Min |

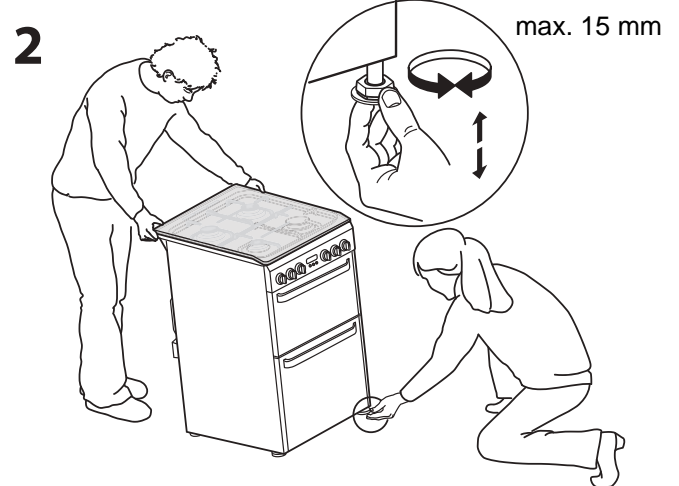
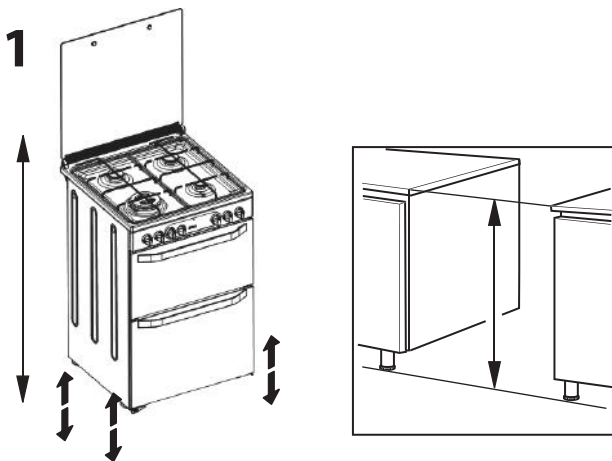

The height of the cooker can be adjusted by means of adjustable feet in the base of the product (900mm - 915mm). To allow alignment with a worktop height greater than 915mm (max 940mm), longer feet are supplied inside your new product. Tilt the the cooker from the side, and the feet can be screwed / unscrewed to achieve the desired height.

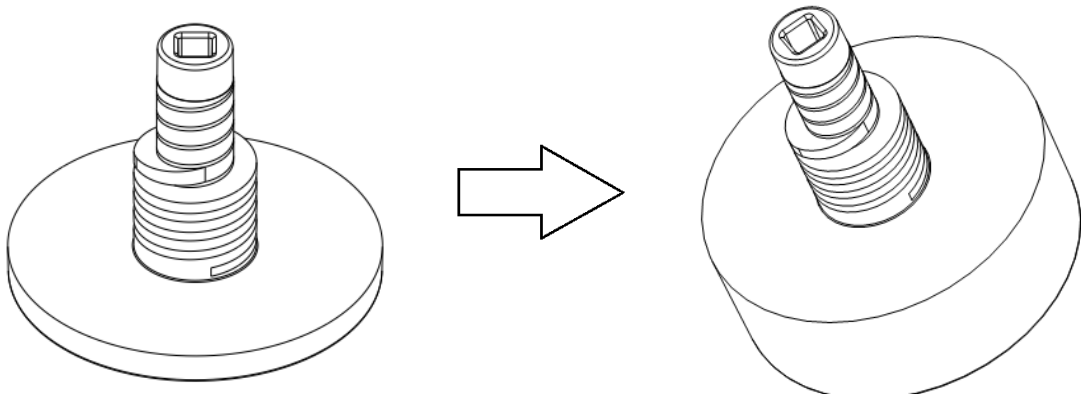

Connecting to gas supply

3

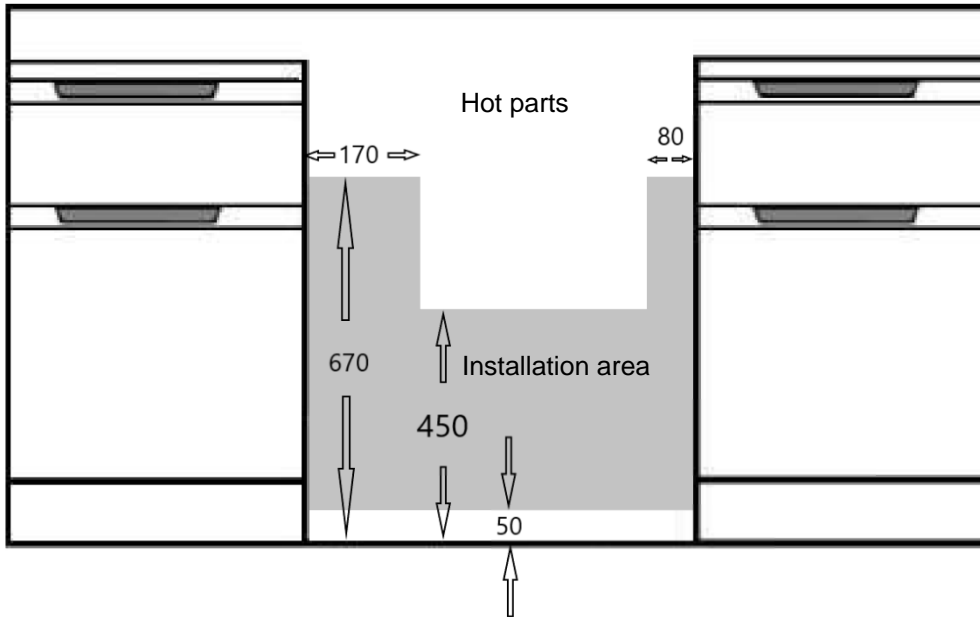

Position the gas connection point such that it is located within the shaded area, and the hose also hangs naturally within the shaded area.

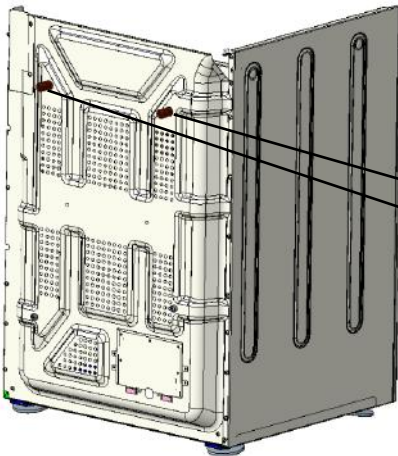

There are 2 spacers on the rear panel of the appliance (see Fig 1) intended to prevent the appliance trapping the flexible hose. If the flexible hose and its rigid pipework connections are recessed, the spacers can be removed by the installer to allow the appliance to be pushed back further in the aperture. This can only be done if the requirements of BS 6172:2010 can still be met.

4

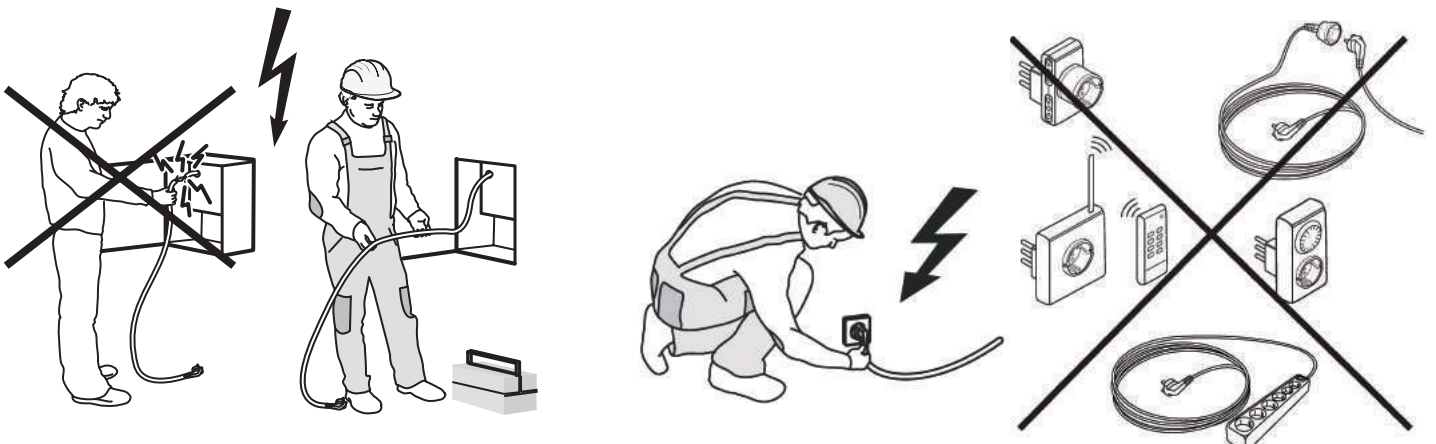

Your new cooker comes with 4 chrome shelf supports packed in the main oven along with the shelves. There are 2 shelf supports for the top oven and 2 for the bottom oven. See Fig. 1.

Fig. 1



Top Oven Shelf Supports

Main Oven Shelf Supports

Fitting - Step 1

The top of the shelf supports engage in slots in the side walls of the oven as in Fig. 2 below. Note the rods 'A' are longer at the top than 'B' at the bottom, and the hooks 'C' are at the back of the oven. It is important that the shelf supports are fitted the correct way around!

Fig. 2

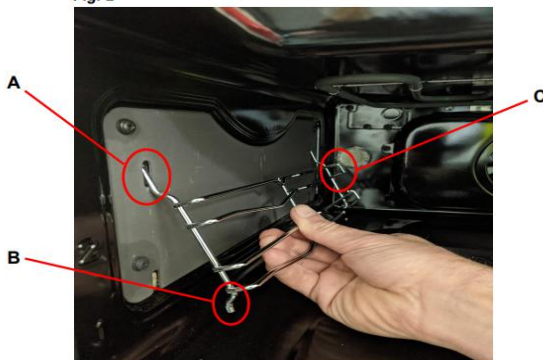

Fitting - Step 2

Once engaged at the top, then push the bottom rods into the lower slots in the oven side walls. Now allow the shelf supports to lower slightly and engage. See Fig. 3.



Fig. 3

This process should be repeated and all 4 shelf supports fitted in the top and main ovens.

Fitting - Step 3

The shelves can now be fitted into the shelf supports at the required heights. Note that there is pan guard 'D' that should be at the back of the oven as shown. See Fig. 4.



Fig. 4

Your ovens are now ready to use !